



DEPARTMENT OF DEFENSE
DIRECTORATE FOR FREEDOM OF INFORMATION AND SECURITY REVIEW
1155 DEFENSE PENTAGON
WASHINGTON, DC 20301-1155

Ref: 00-F-0357

Ms. Christine Spolar
CBS News
555 W. 57th St. - 8th Floor
New York, New York 10019

19 FEB 2000

Dear Ms. Spolar:

This is in response to your November 10, 1999, Freedom of Information Act (FOIA) request, which was received in this Directorate on November 12, 1999.

Mr. Robert L. Jones, Deputy Assistant Secretary of Defense for Prisoner of War/Missing Personnel Affairs (DPMO), an Initial Denial Authority, has provided the enclosed redacted documents as responsive to your request. He has denied some of the redacted information because it is currently and properly classified in accordance with Section 1.5(b), (c) and (d) of Executive Order 12958. The denied portions concern foreign government information; intelligence activities, sources and methods; and foreign relations of the United States, including confidential sources. Other information has been denied pursuant to 50 USC 402 Note Section 6, for the protection of the National Security Agency functions and information and 50 USC 403(g) Section 6 of the CIA Act of 1949 for the protection of CIA functions and information, each determined to be a valid exemption three statute as a result of litigation. Some information has been withheld because its release would result in a clearly unwarranted invasion of personal privacy and would rekindle anguish and grief on the part of family members of Lieutenant Commander Speicher.

Accordingly, the redacted information within the enclosed documents is withheld pursuant to 5 USC 552(b)(1), (b)(3), and (b)(6).

Mr. Jones has denied approximately 470 pages in their entirety, because they are currently and properly classified in accordance with Section 1.5(b), (c) and (d) of Executive Order 12958. The denied information concerns foreign government information; intelligence activities, sources and methods; and foreign relations of the United States, including confidential sources. Additionally, letters to and from the widow of Lieutenant Commander Speicher and her attorneys have been denied in their entirety because their disclosure would result in a

959



clearly unwarranted invasion of personal privacy of an individual.

Portions of the documents withheld in their entirety are also exempt from release in accordance with 10 USC 424, concerning the protection of organizational and personnel information for the Defense Intelligence Agency, the National Reconnaissance Office, and the National Imagery and Mapping Office. Other portions are denied pursuant to 50 USC 402 Note Section 6, for the protection of the National Security Agency functions and information; 50 USC 403-3(c)(6) National Security Act of 1947, Subsection 102(d)(3), as amended, for the protection of intelligence sources and methods of the Central Intelligence Agency (CIA); and 50 USC 403(g) Section 6 of the CIA Act of 1949 for the protection of CIA functions and information, each determined to be a valid exemption three statute as a result of litigation.

Accordingly, the information denied in its entirety has been withheld pursuant to 5 USC 552(b)(1) and (b)(6). Portions of these documents have also been withheld pursuant to 5 USC 552 (b)(3).

You may appeal Mr. Jones' decision to deny the information by offering justification to support reversal of the initial denial. Any such appeal should be postmarked within 60 calendar days of the date above to the Directorate for Freedom of Information and Security Review, Room 2C757, 1155 Defense Pentagon, Washington, DC 20301-1155. The envelope and the letter should be clearly marked "Freedom of Information Appeal" or "Information Appeal." Please cite the FOIA number assigned to your request.

There are no assessable fees for this response.

Sincerely,

H. G. McIntyre
Director

Enclosures:
As stated

Choose One

Lose Interest in Your Mortgage
click here to refinance and save

0.6 1/4 %
GetSmart.com

TO INFORM

APB THE G-FILES

HOT DOCUMENTS FROM THE GOVERNMENT'S VAULTS

AND SERVE

SEARCH THE SITE: **GO**

HOME PAGE MISSING

911 NEWS THE G-FILES

SAFE STREETS BEHIND THE BADGE

SERIAL KILLER BUREAU MAJOR CASES

MEDIA PATROL UNSOLVED

WANTED IN-DEPTH

HELP/FAQ FEEDBACK FORUMS CLASSIFIED

11 E-MAIL ALERT Sign up for APB's e-mail newsletter for updates and breaking news

LIVE POLICE SCANNERS:



FREEDOM OF INFORMATION/PRIVACY ACTS RELEASE

CONFIDENTIAL

NEW REVELATIONS ABOUT MISSING PILOT

First Casualty of Gulf War May Have Survived Crash

Aug. 2, 1999

By Tami Sheheri

WASHINGTON (APBNews.com) — The U.S. Navy pilot whose mysterious 1991 disappearance as the first casualty of the Persian Gulf War sparked a controversy in Congress and the Pentagon may have survived his plane crash in Iraq, according to a Pentagon document obtained by APBNews.com.

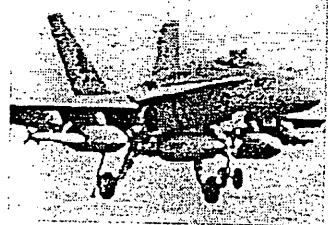

F-18 jet fighter

AP

The new revelation comes in a memo about Lt. Cmdr. Michael S. Speicher authored by an assistant secretary of defense. The memo provides previously unpublished information about Speicher's condition immediately after the crash, as well as about actions that may have been taken by the Iraqis to alter evidence at the crash site.

Speicher, whose F-18 crashed in western Iraq during the opening phase of the war, became a cause for MIA/POW advocates after secret documents obtained from the Pentagon by *The New York Times* in 1998 revealed that a U.S. spy satellite had detected a man-made symbol near the crash site. Speicher is the only U.S. casualty of that conflict whose remains have not been found.

The *Times* reported that shortly after the plane disappeared, some military officials believed Speicher may have survived the crash and that the government had a moral obligation to locate him. U.S. military authorities prepared to launch a secret mission to the site but abruptly canceled those plans. The full details of the affair have never been made public.

Cut out of his flight suit

The July 19, 1999, briefing memo by a

EMAIL THIS STORY TO A FRIEND

G-FILES REPORTS

NEW REVELATIONS ABOUT MISSING PILOT

BOMBING THE U.S. CAPITOL

SPIES BEWARE, U.S. INTELLIGENCE TARGETS SPIES

U.S. LAWYER SUED BY AL FAYED DENIES WRONGDOING

AL FAYED FILES \$5M SUIT OVER ASSASSINATION CLAIM

MYSTERY PHOTO, CIA LINKS AND MOB ASSOCIATIONS

JFK JR. SMUGGER, 25 YEARS LATER

VERSACE'S KILLER: REASONS BEHIND THE RAMPAGE

ROCKY MOUNTAIN HIGH: WAS IT COCAINE?

AL FAYED DEMANDS SPY AGENCY'S DIANA FILES

GEORGE CARLIN LAUGHS AT FBI SCRUTINY

DEA'S SECRET FILE ON SONNY BONO

SECRET U.S. DIANA FILES SUBPOENAED

VINCE FOSTER FBI FILES ONLINE

AL FAYED REACTS TO DIANA SECRET PAPERS REPORT

U.S. SPY AGENCY CONFIRMS SECRET PRINCESS DIANA PAPERS

FBI RELEASES SINATRA FILES

CELEBRITIES

Choose

HISTORICAL FIGURES

#959

The July 19, 1999, briefing memo by a deputy assistant secretary of defense reports for the first time that after the wreckage of Speicher's plane was located, the Pentagon determined that the 33-year-old pilot had been cut out of his flight suit. The memo said that the condition of the flight suit and related equipment indicated that Speicher "was probably severely injured or dead when these items were removed."

At the same time, the memo notes that "the flight suit was lying on the surface with minimal evidence of weathering and minimal adherent soil" - conditions that suggest that the suit was placed there after having been stored somewhere else in Iraq.

"This is a breakthrough," said Dolores Alfond, national chairwoman of the National Alliance of Families for the Return of America's Missing Servicemen (NAFRAMS), an advocacy group for the return of missing servicemen. "Saddam Hussein could be holding a live POW. If they have the flight suit, he's got to have been in it." The Defense Department memo noted that the flight suit and life-support equipment may have been moved after the crash - suggesting that Iraqis may have tampered with the physical evidence at the crash site.

Change in official status?

Until this spring, Defense Department officials still insisted they did not know if there was enough evidence to change Speicher's official status from "killed in action" to "missing in action."

In March, Sens. Bob Smith, R-N.H., and Rod Grams, R-Minn., requested that Speicher's official status of killed in action, body not recovered (KIA-BNA) be changed to missing in action, which would reflect doubt as to whether he survived the crash.

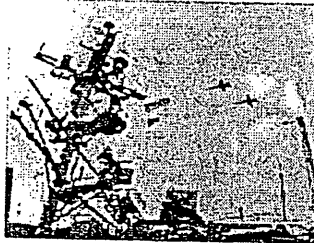

U.S. Navy
F-18s launch off Navy carrier.

According to published reports, the senators were informed March 12 by the Defense Department's POW-Missing Personnel Office that "we don't know" if Speicher may have survived the crash, based on evidence available.

Not Speicher's body

After the war ended and in an act that further complicated the case, the Iraqis handed over remains they claimed belonged to Speicher, but DNA tests and blood typing proved that they were not his.

At the time, Army Gen. John Shalikashvili rejected a plan for a covert operation into Iraq to search for information concerning the crash and Speicher. Reports say he decided the special operation was too dangerous to put other soldiers at risk for a 3-year-old crash. Instead, a Pentagon/Red Cross team arranged a search effort with Hussein's permission, but by the time they arrived, the site had been excavated.

Tami Sheheri is an APBNews.com staff writer (tami.sheheri@apbnews.com).

Choose [v]

THE REAL X-FILES
Choose [v]

CELEBRITY MUG SHOTS
Choose [v]

PHOTOS FROM THE VAULT

G-FILES RESOURCES

FORUMS (Bulletin Boards)
FEEDBACK (E-mail Us)
ALERTS (Get E-mail Alerts)

APB 911 News

KENNEDY SEARCH COST U.S. \$500,000

STUDY: GUN INJURIES COST \$2.3B IN YEAR

FBI REMOVES MAN FROM ATLANTA PLANE

FAMED 'MUSTANG RANCH' BROTHEL CLOSED

U.S. CUSTOMS TO CHANGE SEARCH POLICY

APB Safe Streets

Regulators Target Travel Scams
Federal and state authorities announced actions against 25 travel companies accused of luring consumers with flashy vacation offers and failing to disclose the full terms and costs of their trips.

APB Serial Killer Bureau

The Florida Hog Trail Killings
Six men whose brutalized bodies were found in a junglelike area of southwest Florida may have been tied to trees naked before being strangled, stabbed and worse.

APB Missing

Sandra Anne Evans
Missing from Weirsdale, Fla., since July 12, 1999.

APB:Wanted



Eric Bryan Kuvet
Sought by the U.S. Postal Inspection Service in connection with mail fraud.

APB:The G-Files



Vince Foster's FBI Files Online
A new Hillary Clinton controversy makes the Foster files more topical than ever. Also, FBI documents provide new details on 1971 Capitol bombing. And, new revelations about missing Gulf War pilot.

APB:Unsolved



The Green River Killer Detective Is Listening to You!
Help identify Green River Killing victims, wander through the physical sites, documents and facts of the case.

APB:Major Cases



Cops Seek Dismissal of Diallo Charges
Attorneys for four New York City police officers charged in the killing of Amadou Diallo have asked a judge to dismiss the case, arguing the evidence does not support murder charges.

APB:Media Patrol



Government ordered to pay for assassination record. Plus, could Woodstock riots have been prevented? Also, *Moesha* star arrested in Milwaukee, and is TV's *Buffy* headed for *Hannibal*?

APB:In-Depth



Who Killed Rachel Hurley?
An elite investigative group has been asked to help solve a 1990 murder that haunts Palm Beach, Fla., police.



©Copyright 1999 APB Multimedia Inc. All rights reserved.

► [TERMS OF USE](#)

► [PRIVACY POLICY](#)

Find: A Loan for Me Powered by GetSmart.com

Refinancing Second Mortgage Debt Consolidation



INTERNATIONAL
SECURITY AFFAIRS

OFFICE OF THE ASSISTANT SECRETARY OF DEFENSE
2400 DEFENSE PENTAGON
WASHINGTON, DC 20301-2400

19 JUL 1999
In reply refer to:

Dear

The Defense Prisoner of War/Missing Personnel Office (DPMO) seeks to improve responsiveness to the families and their organizations. That is why I requested your questions in advance of the Annual Government Briefings on current accounting initiatives. I had hoped to provide you specifics at the June 19 meeting. Unfortunately, due to the complexity of the questions and my desire to ensure accuracy, I granted my staff additional time to formulate comprehensive answers for your members.

Attached you will find answers to your questions. Please do not hesitate to call my office to seek additional clarification on the material I have provided you.

Sincerely,

Robert L. Jones
Deputy Assistant Secretary of Defense
(POW/Missing Personnel Affairs)

Attachments:
As stated



last >> next >

Lose Interest in Your Mortgage. **0.8 1/4 %**
[click here](#) to refinance and save. **GetSmart.com**

continue to require further effort. To move this process along, a number of initiatives were discussed with Czech officials.

Over the course of the last year and a half, JCSD personnel have been given access to all Hungarian archives requested. Thus far, we have reviewed archived documents of the Hungarian Workers Party and Hungarian Socialist Workers Party, as well as some of the most sensitive documents of the Ministry of Foreign Affairs and the Ministry of Defense for the entire Cold War period. Government officials have universally informed us that many documents were either taken to the Soviet Union after the Hungarian Uprising in 1956 or destroyed during the fall of the Communist regime in 1989.

Question 3: A briefing on the POW/MIA missing from the Gulf War including an update on the Speicher case.

ANSWER: There were 13 servicemen Killed-in-action/Body-not recovered.

USAF AC-130 Over Water Loss 10 KIA/BNR

USN F/A-18 1 KIA/BNR

USN A-6 Over Water Loss 1 KIA/BNR

USN F/A-18 1 KIA/BNR

Speicher, Michael S., LCDR, USN F-18 17 Jan 91 KIA-BNR

Still an on-going investigation:

On 17 January 1991, LCDR Speicher was shot down over Iraq while flying a suppression of enemy air defense (SEAD) mission west of Baghdad. At 0352 hours, another pilot operating in the vicinity of LCDR Speicher's loss location reported observing an explosion he described as an aircraft being hit by an air-to-air missile. He estimated the position and altitude as 3300N 04220E and 24,000 feet. Reporting indicates a MIG-25 FOXBAT active in the area at the time of this incident. No radio calls or beepers were heard and no signals were observed.

Upon completion of the strike group's mission, search and rescue (SAR) forces were alerted and possible divert airfields were contacted with negative results. LCDR Speicher's crash site was not located prior to termination of Operation Desert Storm. Upon termination of combat operations in Iraq, the Government of Iraq returned remains purportedly associated with LCDR Speicher to U.S. Government control. These remains were later determined not to correlate to LCDR Speicher through blood typing and DNA analysis. Following up on a lead obtained through intelligence sources, LCDR Speicher's crash site was located in April 1994. An ICRC team excavated this crash site at 330114N 0421528E in December 1995.

[< prev](#) [<< first](#) [last >>](#) [next >](#)

Find: A Loan for Me Powered by GetSmart.com

Refinancing Second Mortgage Debt Consolidation

During the excavation, wreckage associated with LCDR Speicher's aircraft was discovered. The team noted a large backfill pile present in the area where the cockpit would have been located, indicating a previous unilateral excavation. In addition, the team discovered a U.S. NOMEX flight suit approximately 3.5 kilometers northeast of the crash site. The flight suit was lying on the surface with minimal evidence of weathering and minimal adherent soil. The team also discovered pilot life support equipment and a 20mm shell approximately 1 kilometer east of the flight suit. The condition of flight suit and pilot related materials, the method in which they were found, and the presence of the 20mm shell indicate that these items may not have originated where they were recovered.

Material analysis of the aircraft wreckage indicates a catastrophic event occurred in the forward part of the aircraft resulting in a power loss and a short duration fire. Indications are that LCDR Speicher then jettisoned the canopy, possibly during the ejection sequence. Analysis of the flight suit and life support equipment indicates these items were cut off the pilot. The condition of the flight suit and life support equipment suggests the pilot was probably severely injured or dead when these items were removed.

Question 4: An update on the progress made in the declassification of documentation relating to POW/MIAs from WW II, the Korean War, the Cold War and Vietnam War. How many documents still remain classified from the different Wars in each Agency??

a. CIA b. DIA c. NSA d. NSC e. NRO f. CIO
 g. Army intelligence h. Air Force Intelligence i. Navy Intelligence
 j. Department of State k. White House

ANSWER: DPMO continues to review for declassification archival as well as contemporary documents pertaining to unaccounted for persons.

- For almost a decade, since 1991, government agencies have made a good faith effort to locate and release POW/MIA documents. Those located have been declassified and released. While additional collections may still be found we believe most of the major collections have been reviewed. DPMO continues to search worldwide. When we find records we copy them and add them to the established collections.
- We have excellent cooperation with counterpart declassification teams throughout DoD and Executive branch departments. Virtually all documents accessed have been reviewed for declassification and made public or are presently being systematically reviewed for multi-agency equities. The process may be slow, but it is consistent and produces results.
- World War II: A significant effort to retrieve WW II records is underway in Eastern Europe. JCSD currently monitors an NGO contract with KARTA in Poland and the Romanian government has provided DPMO with 80 pages of Romanian cemetery schematics, which indicate burial plot locations of US and English service members. These documents are under review. DPMO also has access to a WWII database compiled by the American Battlefield Monuments Commission (ABMC) after war.

[< prev](#) [<< first](#)

**Response to Query of Jan 8, 1999
Florida Times Union
Re Michael Speicher**

Q1. What is the Pentagon's position on what happened to him (Speicher)? Does DoD believe he died in the shutdown or that he survived and died sometime thereafter?

A1. There is no evidence to demonstrate that Lieutenant Commander Speicher survived his loss incident or was ever captured or held as a POW.

(questions regarding radios and ejection seat survivability should be answered by the Navy)

Q. Does the Department of Defense believe that a failure of the Motorola AN/PRC-112 radio played any role in LCDR Speicher's death?

A. There is no evidence to indicate LCDR Speicher's radio played any role in his fate.
(See also answer #1)

Vic:

These answers have the coordination of DPMO, including the Deputy Assistant Secretary of Defense for POW/Missing Personnel Affairs, Mr. Robert L. Jones.

Please ensure Commander Laurie van Buskirk is aware. She is the point of contact in the Navy for this issue, and has been with us at every step of the way as this progressed.

She is in the Office of the Asst Secretary of the Navy, Manpower and Reserve Affairs. Sorry I don't have her phone number.

Larry
602-1245

Navy Asked To Change Pilot's Status

.c The Associated Press

By ROBERT BURNS

WASHINGTON (AP) – Two senators asked Navy Secretary Richard Danzig on Friday to change the Pentagon's official "finding of death" for a Navy pilot shot down in the opening hours of the 1991 Gulf War to "missing in action," reflecting evidence of doubt about whether he survived the crash.

Lt. Cmdr. Michael Speicher of Jacksonville, Fla., went missing when his Navy F-18 Hornet was shot down on Jan. 16, 1991, in an air-to-air battle with an Iraqi fighter jet. He was the first American lost in the war and the last still unaccounted for.

"We believe that the justification for the finding of death determination in May 1991 is no longer valid and conclusive," Sens. Bob Smith, R-N.H., and Rod Grams, R-Minn., wrote in the letter to the Navy's top civilian leader.

The late Adm. Mike Boorda, then the chief of naval operations, approved the official "finding of death" on May 22, 1991. That action changed his official status from missing in action to killed in action.

In September 1998, following efforts by Smith and Grams to learn more about what the U.S. intelligence agencies knew of Speicher's fate, the Senate Select Committee on Intelligence was given a classified chronology of the intelligence agencies' activities on the matter.

"We strongly believe that the information contained therein supports the request we are making of you with this letter," Smith and Grams told Danzig. They did not cite any specific evidence, which is classified secret.

The senators said they were informed on March 12 by the Defense Department's POW-Missing Personnel Office that its position on whether the available evidence indicates Speicher perished in the crash of his plane is "we don't know."

In light of that, Speicher's status should be changed to missing in action – "a status that more accurately reflects the available evidence and provides a presumptive 'benefit of the doubt' to Lt. Cmdr. Speicher," the letter said.

"We owe nothing less to Lt. Cmdr. Speicher and his family," the senators wrote.

Capt. Craig Quigley, spokesman for Danzig, said Friday evening he was not sure whether Danzig had seen the letter yet but that the Navy chief would act as quickly as possible to address the senators' concerns.

Smith and Grams have said before that Pentagon officials initially told them there was no evidence to indicate that Speicher could have survived the crash. However, in May 1994 – more than three years after Speicher went missing – Pentagon officials indicated in a secret memorandum that a U.S. spy satellite had photographed a "manmade symbol" at the crash site earlier that year. Some military officers said they interpreted the symbol as a sign that the Navy pilot might have survived the crash.

Speicher was the only American killed on Iraqi territory whose remains were not recovered.

A plan was devised in 1994 to conduct a covert operation into Iraq to search the crash site for clues to Speicher's fate, but it was scrapped in December 1994 by Army Gen. John Shalikashvili, then the chairman of the Joint Chiefs of Staff. The general ruled that the risk of casualties was too high to justify the secret mission.

In 1995, U.S. crash site specialists from the Defense Department, working with the International Committee of the Red Cross, entered Iraq with President Saddam Hussein's permission. When they got to the crash site they found it had been excavated,

From: RJDES@aol.com
Sent: Friday, August 06, 1999 5:18 AM
To: destatter@osd.pentagon.mil
Subject: New Revelations about Missing Gulf War Pilot

FYI. rjd

--original follows--

New Revelations about Missing Gulf War Pilot

WASHINGTON (APBNews.com)-- The US Navy pilot whose mysterious 1991 disappearance as the first casualty of the Persian Gulf War sparked a controversy in Congress and the Pentagon, may have survived his plane crash in Iraq.

Lt. Cmdr. Michael S. Speicher, whose F-18 crashed in western Iraq, became a cause for MIA-POW advocates after secret documents obtained from the Pentagon in 1998 revealed that a US spy satellite detected a man-made symbol near the crash site. Speicher is the only US casualty of that conflict whose remains have not been found.

The New York Times reported that some military officials believed Speicher may have survived the crash and that the government had a moral obligation to locate him. US military authorities prepared to launch a secret mission to the site but abruptly canceled those plans. The full details of the affair have never been made public.

But in a July 19 briefing memo to the National Alliance of Families for the Return of America's Missing Servicemen (NAFRAMS), a deputy assistant secretary of defense confirmed that after the wreckage of Speicher's plane was located, the Pentagon determined that the 33-year-old pilot was cut out of his flight suit. The memo said that the condition of the flight suit and related equipment indicated that Speicher "was probably severely injured or dead when these items were removed."

"This is a breakthrough," said Dolores Alford, national chairwoman of NAFRAMS, an advocacy group for the return of missing servicemen. "Saddam Hussein could be holding a live POW. If they have the flight suit, he's got to have been in it."

The Defense Department memo noted that the flight suit and life-support equipment may have been moved after the crash -- suggesting that Iraqis may have tampered with the physical evidence at the crash site.

Change in official status?

Until this spring, Defense Department officials still insisted they did not know if there was enough evidence to change Speicher's official status from "killed in action" to "missing in action."

In March, Sens. Bob Smith, R-NH, and Rod Grams, R-MN, requested that Speicher's official status of killed in action, body not recovered (KIA-BNA) be changed to missing in action, which would reflect doubt as to whether he survived the crash.

According to published reports, the senators were informed March 12 by the Defense Department's POW-Missing Personnel Office that "we don't know" whether Speicher survived the crash, based on evidence available.

Not Speicher's body

After the war ended and in an act that further complicated the case, the Iraqis handed over remains they claimed belonged to Speicher, but DNA tests and blood typing proved that they were not his.

At the time, Army Gen. John Shalikashvili rejected a plan for a covert operation into Iraq to search for information concerning the crash and Speicher. Reports say he decided the special operation was too dangerous to put other soldiers at risk for a 3-year-old crash. Instead, a Pentagon-Red Cross team arranged a search effort with Hussein's permission, but by the time they arrived, the site had been excavated.

Speicher inquiry may go forward

By John Fritz
Times-Union staff writer

After a classified briefing by Pentagon officials yesterday, U.S. Sen. Bob Smith, R-N.H., believes a Senate inquiry into the downing of a Jacksonville-based FA-18 pilot during the Gulf War is still warranted.

Despite the 90-minute session, also attended by fellow Sen. Rod Grams, R-Minn., Smith "still has some concerns," said his spokeswoman, Lisa Harrison. She said the senator could not elaborate.

The Senate Select Committee on Intelligence has agreed to investigate the case of Navy Lt. Cmdr. Michael Scott Speicher, whose remains never were found but who was declared dead after the war.

Smith and Grams requested the inquiry, saying recent press accounts raise "serious questions as to whether both of us

may have been misled by the administration" in previous queries.

The senators are interested in what is known about the fate of Speicher, a fighter-bomber pilot from Cecil Field Naval Air Station and the only U.S. serviceman unaccounted for in Iraq.

In a letter to the chairman of the intelligence committee, Sen. Richard Shelby, R-Ala., the senators said they previously had been told there was no evidence to indicate Speicher might have survived.

But recent reports in The New York Times cite Pentagon documents that say a spy satellite "detected a man-made symbol in the area of the ejection seat," the senators said.

The newspaper also reported that some senior military officers thought Speicher might have survived, but a covert operation to search the crash site was scrubbed in 1994 by the then-chairman of the Joint Chiefs of Staff, retired Gen. John Shalikashvili.

The pilot's widow, who has since remarried, has declined interviews. His cousin, Bill Speicher of Jacksonville, would like a more complete report.

Is Search for Missing Too Risky for Soldiers?

To the Editor:

A Dec. 7 front-page article reports the decision by Gen. John M. Shali-

kashvili, then chairman of the Joint Chiefs of Staff, not to allow a 1994 secret mission to Iraq to bring back a Navy pilot missing in the Persian Gulf war because it would be too risky.

Special-operations soldiers would

have been willing to volunteer for the mission, despite the possibility of losing their own lives. It has always been an unwritten code of the military that we do not leave our people behind.

If those who serve our country cannot feel that all efforts will be made to extricate them, if necessary, from enemy territory, our best service people will leave.

Some of today's military leaders appear too timid to uphold this basic doctrine. The civilian leaders who certify such decisions are equally at fault. As graduates of the service academies, we recall an old saying in the military: Loyalty down breeds loyalty up. Some of our leaders don't seem to understand the meaning of that.

JOHN F. FLANAGAN

ERIC D. ROSEN

New York, Dec. 11, 1997

The writers are, respectively, a retired Air Force Reserve brigadier general and a former Navy lieutenant.

What risks to recover a long-dead U.S. pilot?

Two days before Gen. John Shalikashvili was confirmed as head of the Joint Chiefs of Staff in 1993, U.S. Army Rangers were pinned down in the streets of Mogadishu. Eighteen were killed and 75 were wounded because they refused to abandon the body of a dead helicopter pilot.

It was an extraordinary display of courage. But many non-Rangers asked themselves if the recovery of one dead American was worth the creation of 18 more dead Americans. The Rangers and the Marines are steeped in a stern military tradition of never, ever abandoning a fallen comrade - even if it means risking or sacrificing more lives. That is a bedrock value of these elite units. But should it be the policy of the entire U.S. military?

The question came up again, soon after the debacle at Mogadishu, when an Arab hunting party reported finding the wreckage of a Navy warplane about 100 miles southwest of Baghdad. It had been flown by Lt. Cmdr. Michael Speicher, who had been listed as killed in action nearly three years earlier after being shot down over Iraq in the first hours of the Persian Gulf War. The Pentagon began making plans to enter Iraq covertly and sift through the crash site for Speicher's remains.

But Shalikashvili reportedly vetoed this operation, saying, "I do not want to have to write the parents and tell them their son or daughter died looking for old bones." By the time a Pentagon team was able to examine the site - with Iraq's permission - the

wreckage had been thoroughly scavenged by the Iraqis. Speicher's remains have never been recovered.

Shalikashvili, who recently retired to a home in Steilacoom, has come under attack for his decision. Some of the critics believe the dangers involved in trying to recover Speicher's body from hostile territory were low enough to justify the operation. Others believe the operation should have been undertaken regardless of the danger.

Bear in mind, though, that it was also on Shalikashvili's watch that the military took great risks to rescue Capt. Scott O'Grady after the Air Force pilot was shot down over Serb-held territory in Bosnia in 1995. Those risks were fully justified by the prospect of keeping O'Grady out of the hands of brutal thugs. But risks were not taken on behalf of another pilot who was almost certainly long since deceased. From this corner, the logic appears sound: Rangers and Marines aside, the military's responsibility to its dead does not override its responsibility to the living.

Senate to Review Fate of Gulf War Pilot Downed Over Iraq

By TIM WEINER

WASHINGTON -- At the request of two senators who say the Pentagon may have misled them, the Senate Select Committee on Intelligence will inquire into the fate of the only Persian Gulf war pilot who remains unaccounted for, intelligence committee staff members said on Thursday.

The senators, Rod Grams of Minnesota and Robert C. Smith of New Hampshire, both Republicans, asked the committee to look into what U.S. intelligence services know about the disappearance of Navy Lt.

Cmdr. Michael Scott Speicher, the first American to fall in the gulf war.

Listed as missing in action after his plane crashed, the pilot was never heard from again. He was soon listed as "killed in action -- body not recovered." But Pentagon officials told The New York Times last week that they do not know whether he could have ejected and survived.

In a letter to the chairman of the intelligence committee, Sen. Richard Shelby, R-Ala., the senators said they "may have been misled" by Pentagon officials who had previously told

them "that there was no evidence which indicated Commander Speicher (pronounced spiker) may have survived."

In an interview, Smith -- who has a longstanding interest in American soldiers thought to be prisoners of war or missing in action -- said that he had been asking Defense Department officials about Speicher for two years.

In 1995, he said, he was told unofficially "that there was intelligence that indicated that Speicher may have ejected" from his F-18 fighter jet before it crashed in western Iraq during the first hours of the war.

Smith said he received a classified Pentagon briefing about Speicher in January 1996. He said he came away from the briefing believing that there was no chance Speicher could have ejected, that the

Pentagon had never planned a covert operation to search the crash site, and that there was no evidence that the pilot could have sent a distress signal to rescuers after his crash.

But according to Pentagon documents and Pentagon officials interviewed last week, there was a chance that Speicher could have ejected and survived; there was a plan -- never executed -- to launch a covert mission to search the crash site; and there was some kind of "man-made symbol" at the crash site, which was detected by a Pentagon spy satellite in 1994.

"Apparently I was misled," Smith said on Thursday.

Grams, prompted by members of a Minnesota prisoners-of-war and missing-in-action advocacy group, wrote the Pentagon twice this year about

Speicher. In a second letter, seeking a clarification he asked if "any symbols were found in the area" where Speicher's plane crashed. Downed pilots are taught to make a specific symbol seeking assistance from rescuers -- or any kind of symbol that can be read from the sky as a cry for help.

Pentagon officials wrote back to the senator saying that their investigation had found "no symbols that correlate to civilian or military distress symbols or evasion codes."

But in a secret memorandum dated May 11, 1994, more than three years after the plane went down, Pentagon officials noted that a U.S. spy satellite had photographed "a man-made symbol" at the crash site earlier that year. Although it was not the distress symbol Speicher had been trained to make, some military officers said they interpreted it as a sign that he might have survived.

The intelligence committee's inquiry will probably be limited to a review of U.S. intelligence

files on the case. It would not re-examine the question of why the Pentagon rejected a secret plan to search the crash site three years ago, intelligence committee staff members indicated. They said that the issue was best left for the committees overseeing the armed services.

Speicher went down in a dogfight with Iraqi jets, the only such incident of the gulf war. The incident raised several other disquieting issues.

Though Navy officials say

they may never know precisely what happened to his plane, a fellow Navy pilot detected the Iraqi MIG-25 that Navy officials say might have later hit Speicher's plane with an air-to-air missile. But the pilot was not allowed to fire on the Iraqi jet without clearance from an Air Force AWACS radar plane. The AWACS -- which stands for airborne warning-and-control system -- could not identify the Iraqi jet as the enemy. Minutes later, Speicher's plane exploded.

Senate Inquiry On Fate of Pilot Lost Over Iraq

By TIM WEINER

WASHINGTON, Dec. 11 — At the request of two Senators who say the Pentagon may have misled them, the Senate Select Committee on Intelligence will inquire into the fate of the only Persian Gulf war pilot who remains unaccounted for, committee staff members said today.

The Senators, Rod Grams of Minnesota and Robert C. Smith of New Hampshire, both Republicans, asked the committee to look into what the intelligence services know about the disappearance of Navy Lieut. Cmdr. Michael Scott Speicher, the first American to fall in the gulf war.

Listed as missing in action after his plane crashed, the pilot was never heard from again. He was soon listed as "killed in action — body not recovered." But Pentagon officials told The New York Times last week that they do not know whether he could have ejected and survived.

In a letter to the chairman of the intelligence committee, Sen. Richard C. Shelby, Republican of Alabama, the Senators said they "may have been misled" by Pentagon officials who previously told them "that there was no evidence which indicated Commander Speicher may have survived."

In an interview, Senator Smith said that for two years he had been asking Defense Department officials about Commander Speicher (pronounced spiker).

In 1995, he said, he was told unofficially "that there was intelligence that indicated that Speicher may have ejected" from his F-18 fighter jet before it crashed in western Iraq during the first hours of the war.

Senator Smith said he received a classified Pentagon briefing in January 1996 and came away believing there was no chance Commander Speicher could have ejected.

But according to Pentagon documents and Pentagon officials interviewed last week, there was a chance that Commander Speicher could have ejected and survived; there was a plan — never executed — to launch a covert mission to search the crash site; and there was some kind of "man-made symbol" at the crash site, which was detected by a Pentagon spy satellite in 1994.

"Apparently I was misled," Senator Smith said today.

Copyright 1997 The Chronicle Publishing Co.
The San Francisco Chronicle

DECEMBER 9, 1997, TUESDAY, FINAL EDITION

SECTION: EDITORIAL; Pg. A22; EDITORIALS

LENGTH: 346 words

HEADLINE: U.S. Pilot Abandoned in Iraq

BODY:

NEARLY SEVEN years after Navy pilot Lieutenant Commander Michael Speicher vanished in Iraq during the first hours of the Persian Gulf War, the U.S. government still doesn't know if he is dead, alive or even a prisoner of Saddam Hussein.

The Pentagon's shamefully long-delayed and timid efforts to find Speicher were reported last Sunday in the New York Times. According to the Times, some senior military officers believe the 33-year-old Speicher may have ejected from his F-18 and survived, but a secret mission to retrieve evidence from the crash site years later was scrubbed because top Pentagon officials were afraid to try.

Last week retired General John M. Shalikashvili, former chairman of the Joint Chiefs of Staff, explained the decision not to send specially trained troops to the crash site in 1994, three years after the crash. "There was no overwhelming need to put our soldiers at risk to covertly search a three-year-old crash site," he told the Times.

Shalikashvili's concern for the safety of the troops is laudable. But the weak-kneed decision not to go into a defeated Iraq in search of the downed pilot until four years after the last shots were fired reflected an unseemly timorousness among the top brass that could chill other soldiers, sailors, airmen and Marines sent in harm's way.

There is a long and honorable American military code that requires commanders to take every reasonable risk to recover fallen comrades from the battlefield. Yet officers were ignored who insisted they had a moral obligation to go after Speicher, whether he was dead or alive.

When an American team finally went into Iraq in December 1995, -- with Saddam's permission -- the crash site had been scavenged.

LEVEL 1 - 12 OF 1986 STORIES

Copyright 1997 Newsday, Inc.
Newsday (New York, NY)

December 8, 1997, Monday, ALL EDITIONS

SECTION: NEWS; Page A18

LENGTH: 625 words

HEADLINE: WORLD/NATION BRIEFS

BYLINE: COMPILED FROM NEWS DISPATCHES

BODY:

No Search for Gulf War Pilot

The nation's highest ranking military officer scrapped a covert operation into Iraq to search for a Navy pilot who crashed during the Persian Gulf War, saying the mission wasn't worth the risk, The New York Times reported yesterday.

Some senior officials said they had a moral obligation to bring Lt. Cmdr. Michael Speicher back dead or alive, and some thought the 33-year-old F-18 pilot might have survived. He was the first American lost in the 1991 war and the only one whose fate remains unknown.

Special-operations soldiers had planned a secret mission to scour the site for clues. And although some said the chances of success were high, Pentagon leaders balked, fearing the risks outweighed the rewards, the newspaper said.

In 1994, Gen. John Shalikashvili, chairman of the Joint Chiefs of Staff, opted against the proposed secret mission, the newspaper said. Although a final decision was made in 1995 by Secretary of Defense William Perry, the military option was effectively killed when Shalikashvili rejected it in December, 1994. "There was no overwhelming need to put our soldiers at risk to covertly search a 3-year-old crash site," Shalikashvili, now retired, said in a statement to the newspaper.

Copyright 1997 Times Printing Company
The Chattanooga Times

December 8, 1997, Monday

SECTION: National; Pg. A5

LENGTH: 378 words

HEADLINE: Gen. Shalikashvili rejected pilot hunt

BYLINE: The Associated Press

BODY:

NEW YORK -- The nation's highest-ranking military officer scrapped a covert operation into Iraq to search for a Navy pilot who crashed during the war, saying the mission wasn't worth the risk, The New York Times reported Sunday.

Some senior officials said they had a moral obligation to bring Lt. Cmdr. Michael Speicher back dead or alive, and some thought the 33-year-old F-18 pilot might have survived. He was the first American lost in the 1991 Persian Gulf War and the only one whose fate remains unknown.

Special-operations soldiers planned a secret mission to search the site for clues. And although some said the chances of success were high, Pentagon leaders balked, fearing the risks outweighed the rewards, the newspaper said.

In 1994, Gen. John Shalikashvili, chairman of the Joint Chiefs of Staff, voted against the proposed secret mission, the newspaper said.

Although a final decision was made in 1995 by Secretary of Defense William Perry, the military option was effectively killed when Shalikashvili rejected it in December 1994.

"There was no overwhelming need to put our soldiers at risk to covertly search a 3-year-old crash site," Shalikashvili, now retired, said in a statement to the newspaper on Friday. "To send America's sons and daughters into harm's way is the most serious recommendation a military leader can make. This is a sacred trust."

But other officers said the responsibility to look for a fallen comrade outweighed the risk of casualties.

"The warriors believed they had a responsibility," said Stan Arthur, a retired four-star admiral who led allied naval forces during the Gulf War. "You lose one of your own, you go back and find him."

A year after Shalikashvili's decision, a Pentagon team working with the Red Cross entered Iraq with Saddam Hussein's permission. When they got there, they found that the site had already been excavated -- most likely by Iraqi officers -- while the Pentagon searched for the safest route to the site.

Searchers still do not know if he bailed out of his plane successfully or if he could have survived the crash.

He is classified as killed in action, body unrecovered. Speicher was the only American killed on Iraqi territory whose remains were not recovered.

LANGUAGE: ENGLISH

AD-DATE: December 9, 1997

Missing pilot's cousin wants full accounting

By John Fritz
Times-Union staff writer

If there were a chance Michael Scott Speicher survived the downing of his Jacksonville-based Navy jet over Iraq, the military had an obligation to go after him, a relative said yesterday after a report the Pentagon scrubbed a covert search.



Speicher

"It wouldn't surprise me in the least to know our government decided he was possibly alive but didn't want to risk any more people or risk an incident over one person," said the pilot's cousin, Bill Speicher of Jacksonville.

The New York Times reported Sunday that the nation's highest-ranking military officer scrubbed a covert operation to search for Lt. Cmdr. Speicher after the Pentagon learned where his FA-18 fighter-bomber crashed.

"There was no overwhelming need to put our soldiers at risk to covertly search a 3-year-old crash site," retired Gen. John Shalikashvili, the former chairman of the Joint Chiefs of Staff, told the Times.

But some senior officers said they had a moral obligation to find Speicher, dead or alive, and some thought he might have survived, the paper reported.

Speicher, who was based at Cecil Field Naval Air Station, officially is listed as killed in action. He is the only U.S. serviceman lost in Iraq whose remains have not been recovered.

Instead of the covert military operation, a Pentagon team working with the Red Cross and with Iraq's cooperation searched the site in December 1995. The site, however, had been excavated by the time they got there.

"If there was any chance he was alive, I think the American military owed that to him," Bill Speicher said of a full military search. "I'd like to have a more complete report of what the Navy knows or doesn't know."

Bill Speicher is the pilot's only relative in Jacksonville. His mother and father both are dead; his widow is remarried and has not commented on the situation.

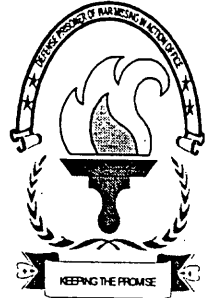

Defense POW/Missing Personnel Office

Subject: Gulf War Cases with the Status Killed in Action/Body Not Recovered (KIA/BNR)

From the moment that President Bush committed U.S. forces to Operation "Desert Storm", the Joint Force Commander established a smooth functioning Joint Search and Rescue Center, which directly contributed to there being no unaccounted for service personnel from this conflict. This significant accomplishment proved the importance of specially trained units, dedicated to conduct rescue operations. There are, however, 13 individuals, lost in four incidents, whose final status is listed as KIA/BNR. Three of these cases involve overwater losses where a significant search and rescue effort was expended. The final result of these rescue efforts was a determination that it is not possible to recover the remains. The DPMO continues to investigate and pursue every avenue toward possible repatriation of remains involving the overland case.

The purpose of this paper is to provide the status of each case from the Gulf War where individuals are declared KIA/BNR. The following is a brief synopsis of each case:

1. Fourteen men were Killed in Action when a USAF AC-130 crashed in the Persian Gulf, off the Saudi/Kuwaiti Coast, on 31 January 1991.



Extensive SAR efforts at the time failed to locate any wreckage or survivors. After the war, part of the wreckage was located on the edge of the continental shelf and the remains of four crewman were recovered. Recovery efforts for the remaining 10 crewmembers' remains were called off for

safety reasons after the portion of the aircraft containing the remains went over the edge of the shelf and settled in water too deep to allow a safe recovery of the remains. Individuals listed as KIA/BNR are:

Maj P.J. Weaver
SMSGT P.G. Buege
SSGT J. Oelschlager
SSGT B.M. Clarke

Capt A. Galvan
MSGT J.B. May
SSGT J. Blessinger

1Lt T.C. Bland
TSGT R.K. Hodges
SSGT T.R. Harrison

2. LCDR B.T. Cooke and LT P.K. Connor's A-6 crashed in the waters off Kuwait City on 2 Feb 1991. SAR forces found no evidence of survivors, only some aircraft wreckage floating on the surface of the water. LT Connor's remains eventually washed ashore and were recovered. LCDR Cooke's remains and the wreckage of the A-6 were never located. The Navy has declared him lost at sea, KIA-BNR.
3. LT R.J. Dwyer's F/A-18 was returning from a combat mission when it crashed in the Persian Gulf on 5 February 1991. At the time of his loss, he was in allied controlled waters and being tracked by Navy radar. An extensive search of the loss site failed to locate him or his remains. Hypoxia is suspected as to the cause of the mishap. The Navy has declared LT Dwyer lost at sea, KIA-BNR.
4. LCDR M.S. Speicher's F/A-18 aircraft was shot down, 17 January 1991, the first night of the Persian Gulf War. His crash site was located west of Baghdad in 1994. In December 1995, the Department of Defense (DoD) dispatched investigators from the United States Army Central Identification Laboratory, Hawaii, and from the United States Navy to Jordan to form the nucleus of an investigative team led by the International Committee of the Red Cross. The team entered Iraq, with the permission of the Iraqi Government, located the crashsite, and thoroughly investigated the site. Based on evidence they recovered, the determination of KIA/BNR provides an accurate accounting status as determined by the individual Service Secretary. DPMO continues to work through the International Committee of the Red Cross with the Iraqi Government to resolve this case fully.

The New York Times

Copyright © 1997 The New York Times

NEW YORK, SUNDAY, DECEMBER 7, 1997

\$3 beyond the greater New York

Gulf War's First U.S. Casualty Leaves Lasting Trail of Mystery



A DOWNED PILOT Lieut. Comdr. Michael Speicher vanished in a gulf war crash. Fear of risks kept the Pentagon from the site, where the F-18's canopy (below) remained, and apparently Iraq got there first.

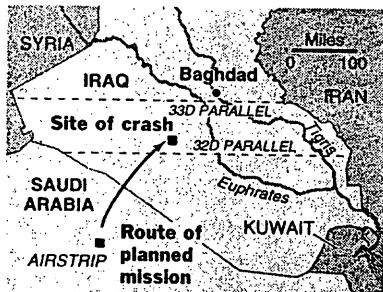

THE CRASH

JAN. 16, 1991 F-18 crashes in the Iraqi desert.

DECEMBER 1993 Remains of the plane are found. No sign of pilot.

THE PLANNED MISSION

FEBRUARY 1995 Troops train for mission; never executed, to scour the crash site.

Jet Ruins Were Found but the Pilot's Fate Is Still Unknown

By TIM WEINER

WASHINGTON, Dec. 6 — Four years ago, a hunter looking for wild game in western Iraq stumbled across the ruins of an American fighter jet.

It was the missing Navy F-18 piloted by Lieut. Comdr. Michael Scott Speicher, the first American lost in the 1991 Persian Gulf war, and the only one whose fate remains unknown. The Pentagon, alerted by the hunter, sent a spy satellite over the crash site. It "detected a man-made symbol in the area of the ejection seat," Pentagon documents say.

Some senior officers thought Commander Speicher might have survived the crash. They said they had a moral obligation to bring him back, dead or alive, no matter how long it took. So special-operations soldiers planned a secret mission to scour the site for clues. Their chances of success were high, they said, and the risks of an Iraqi response very low. But the Pentagon's leaders balked, fearing that the risks outweighed the rewards.

Gen. John M. Shalikashvili, then Chairman of the Joint Chiefs of Staff, scrubbed the plan, saying, "I do not want to have to write the parents and tell them that their son or daughter died looking for old bones," according to Timothy G. Connolly, then principal assistant deputy secretary of Defense for special operations, and other senior officers who witnessed the general's statement in December 1994.

General Shalikashvili, now retired, confirmed his decision and its rationale in a written statement on Friday. "There was no overwhelming need to put our soldiers at risk to covertly search a three-year-old crash site," he wrote.

To advocates of the secret mission, his decision reflected the agonies of an army trying to do its duty without risking its soldiers. "This mentality of 'no losses' has more ramifications than people realize," said one general officer who requested anonymity. "The idea we can do everything so well that we shouldn't ever suffer a loss or casualty invades everything. It keeps you from doing what's necessary."

The advocates said the obligation to look for a fallen comrade should have outweighed the risk of casualties. "The warriors believed they had a responsibility," said Stan Arthur, who retired as a four-star admiral after leading allied naval forces in the gulf war. "You lose one of your own, you go back and find him. The more modern concept was that you can't take the risk of a loss."

Those who opposed the secret mission to Iraq recalled the searing televised images of the Army Rangers who were killed in Somalia in 1993 trying to recover fallen comrades — and the public pillorying that their commanders took from Congress and the news media. They knew the costs of failure were high. They

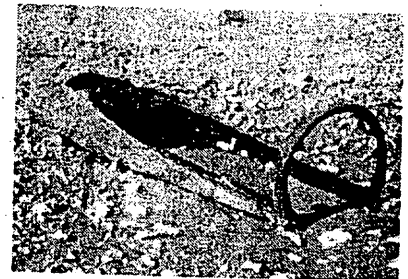

Continued on Page 6

Fate of a Jet Pilot, Gulf War's First U.S. Casualty Leaves Lasting Trail of Mystery

Continued From Page 1

thought the mission too dangerous, even though the Pentagon's Joint Special Operations Command assessed the risks as "low" or "very low." Their idea was safer and, they believed, smarter: working with the Red Cross to enter Iraq with a team of skilled forensic experts.

In the end, the Pentagon took the least risky route. Two years after the discovery of the wreckage, and a year after General Shalikashvili's decision, a Pentagon team entered Iraq openly, with Saddam Hussein's permission, under the banner of the Red Cross.

The searchers still do not know if Commander Speicher bailed out successfully. They still do not know if he could have survived the crash.

They found to their dismay that, just as the advocates of a secret military mission had feared, the crash site had been excavated, most likely by Iraqi officers, during the months that the Pentagon searched for a safe route to the wreckage.

This account is based on Pentagon documents and interviews with present and former military officials.

The Pilot

A Fallen Soldier, A Vanishing Point

On Jan. 17, 1991, in the first hours of the gulf war, Michael Scott Speicher, 33, went down in a dogfight over western Iraq. The Navy spent months trying to understand why. It might have been an Iraqi air-to-air missile, but no one knows for sure.

His father, Wallace, had hopes that he might have survived. "Scotty's coming home," he said three days later. But he was listed as "killed in action — body not recovered." Com-

mander Speicher's wife, who has since remarried, wants to preserve her privacy.

When the war was over, "the Iraqis returned 1.5 pounds of human flesh they claimed belonged to a pilot named 'Michael.'" Pentagon documents say. "Subsequent DNA tests determined the remains were not Speicher."

Pentagon officials still wonder whether this was a deliberate Iraqi attempt to deceive the United States about Commander Speicher's fate.

The hunting party that found his plane was led by a senior military officer from Qatar, an emirate bordering Saudi Arabia. The Qatari officer brought home pictures of the plane's canopy, a shard of metal with serial numbers, and memories of seeing an ejection seat. He gave them all to officials at the United States Embassy in Qatar. The numbers on the shard were proof.

Moral codes and military traditions compelled the Pentagon to look for Commander Speicher's remains — or a shred of evidence that he might have lived. These old codes can spawn dark thoughts. One former Navy officer says he has had nightmare visions of Saddam Hussein suddenly appearing on CNN, leading Commander Speicher with a rope, saying: "Here's a man without a country. I'm tired of feeding him. Who wants him?"

On April 15, 1994, officials from the Office of the Secretary of Defense, the Joint Chiefs of Staff, the Navy, the State Department and the C.I.A. discussed "a covert/ clandestine military action to investigate the crash site," the Pentagon documents say.

That was a far better idea than "openly approaching Baghdad" to request permission for a search, the group agreed. They said that an open approach could reveal the location to the Iraqis, which "would likely jeopardize the site's integrity." The Iraqis had scavenged every other

Desert Storm crash site.

A separate military intelligence analysis warned the Joint Chiefs that "the location of the site would be divulged and subsequent investigations thwarted by Iraqi intelligence exploitation" if the United States openly approached Baghdad.

On May 11, 1994, J. Alan Liotta, chief of the Pentagon's prisoner of war/missing in action office, wrote to the Joint Chiefs, "Access to the wreckage remains our only way to determine conclusively what happened to Lieut. Comdr. Speicher."

He continued: "For us to account successfully for Lieut. Comdr. Speicher, the mission ideally would need to retrieve and return the ejection seat and canopy." The mission also needed the black boxes in which data on the cockpit and engine were stored. Those boxes, he said, "should have survived the crash and would provide vital clues to what the plane and the pilot were experiencing during the flight's last minutes."

The issue was clear, said Admiral Arthur, then the vice chief of naval operations: "Did we or did we not have a lost pilot?"

He said he believed there was a chance that Commander Speicher had ejected successfully and survived. "We know there was an ejection attempt," he said. "I thought he bailed out. I was adamant that we get back in there."

The Strategists

Several Scenarios, None Without Risk

But for six months, the nation's military leaders maintained what the documents call "a holding pattern."

On Dec. 23, 1994, Defense Secretary William Perry, General Shalikashvili, Mr. Connolly and at least four other Pentagon officials, includ-

ing Frederick C. Smith, the assistant secretary for international security affairs, discussed their options.

Mr. Connolly and others favored the military mission. Four helicopters carrying a special-operations team would cross the Iraqi border from Saudi Arabia at night. The team would return with everything it could find — black boxes, bones, wiring from the cockpit, fragments of metal and any other clues.

Mr. Smith and others favored the diplomatic course: openly approaching Baghdad through the International Committee of the Red Cross. The Red Cross would ask Baghdad for permission to go to the crash site with a forensic team from the Pentagon. The team could work at length, without danger.

Mr. Connolly said he warned that the diplomatic option would alert the Iraqis and ultimately fail. Addressing Mr. Perry and General Shalikashvili, he quoted the fifth stanza of the Army Rangers' creed: "I will never let a fallen comrade fall into the hands of the enemy."

The choice ultimately lay with Mr. Perry, and a final decision did not come until March 1995. But the military option effectively died that day when General Shalikashvili opposed it with his statement about old bones.

"To send America's sons and daughters into harm's way is the most serious recommendation a military leader can make," General Shalikashvili said in his written statement on Friday. "This is a sacred trust."

"I concluded that there was no overwhelming need to put our soldiers at risk to covertly search a three-year-old crash site when the Red Cross option was available," he said in his statement. "I stand by that decision."

Mr. Connolly, who left the Pentagon last year to teach, said this week: "Our senior civilian and military leaders were simply too afraid of the possibility of failure, however remote, and refused to allow this pilot's comrades to go into Iraq and bring him home. I wish I could tell you it was more complex than that, but it wasn't."

On Jan. 4, 1995, Mr. Perry told Secretary of State Warren M. Christopher that they should ask the Red Cross to approach the Iraqis.

The Red Cross was amenable. On Feb. 14, its Middle East director, Michel Cagneaux, met with Iraqi officials in Baghdad. "Iraqis listened intently; took copious notes," Mr. Smith, the assistant secretary of defense, wrote that day after talking to the Red Cross.

The next morning, the special-operations team went through a full-dress rehearsal in the New Mexico desert for their mission, which they code-named Isolated Ivory, presumably an allusion to Commander Speicher's bones. But their services would not be needed.

On March 1, 1995, the Red Cross told the Pentagon that Iraq would cooperate. "Conceivably," Mr. Smith wrote, "this mission could go next week." The mission was named Operation Promise Kept.

Throughout the spring, a Pentagon spy satellite photographed the crash site every three days. The wreckage was undisturbed, military intelligence analysts reported in April.

"Our team is ready to go," Mr. Smith told his superiors on May 2, 1995. But a report to General Shalikashvili from his staff three weeks later warned of unforeseen delays, "due to 'bureaucratic problems' within the Iraqi Government."

It would be six more months before the team entered Iraq.

The Site

Tatters and Shards, But Not One Bone

In December 1995, two years after the Qatari officer's discovery and one year after General Shalikashvili's decision, the team arrived at the crash site.

The site had been scavenged.

"It appeared that people had been there before we arrived," Mr. Smith said in an interview on Friday.

There was no ejection seat. There were no bones.

Bedouin nomads handed the team a tattered flight uniform. Mr. Smith would not discuss what a subsequent analysis of the suit showed.

An officer familiar with the team's findings said that it recovered one of the plane's data recorders from the Bedouins.

"The evidence showed the pilot successfully ejected from the aircraft," he said.

Mr. Smith and Mr. Liotta would not confirm or deny that. They said only that the team had emerged with a clearer picture of what happened to Commander Speicher. That picture, like everything else about the case, remains officially secret.

Could he have survived the crash?

"We don't know," Mr. Liotta said. The investigation continues. Commander Speicher is still listed as "killed in action — body not recovered." The first American to fall in the Persian Gulf war remains the last to be accounted for.

Horn, John R.

From: Pasquerella, Robert T.
Sent: Monday, October 25, 1999 3:35 PM
To: Corneliussen-James, Dian LtCol
Subject: patch.ppt



patch.ppt

1

U

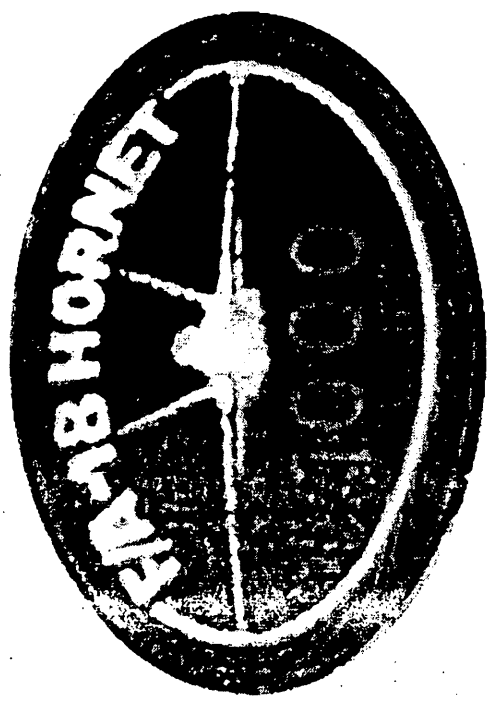

Horn, John R.

From: Gray, Laurie
Sent: Monday, October 25, 1999 2:46 PM
To: Pasquerella, Robert T.
Subject: Patch Photo

CLASSIFICATION: UNCLASSIFIED
CAVEATS: NONE
TERMS: NONE



patch.jpg

CLASSIFICATION W/O ATCH: UNCLASSIFIED
CAVEATS W/O ATCH: NONE
TERMS W/O ATCH: NONE

CLASSIFICATION: UNCLASSIFIED
CAVEATS: NONE
TERMS: NONE



United States Senate

WASHINGTON, DC 20510

March 19, 1999

The Honorable Richard Danzig
Secretary of the Navy
Pentagon, Room 4E686
Washington, D.C. 20350-1000

Dear Secretary Danzig:

We are writing to request that you use your authority under Title 37, USCS, Section 555 (a) and 556 (d) to reconsider and change or modify the "finding of death" determination made by the Secretary of the Navy's designee on May 22, 1991 with respect to Lt. Cmdr. Michael Scott Speicher, USN. We strongly believe, for the reasons noted below, that such action is indeed "warranted by information that has been received and other circumstances," as provided for in the above-cited law. We have further been advised that status determinations with respect to Lt. Cmdr. Speicher are not currently covered by the Missing Persons Act, Title 10, USCS, Sections 1501-1510, as amended, thereby making action under Title 37 appropriate.

Lt. Cmdr. Speicher was the first American to be listed as missing in action when his F-18 was lost over Iraq during a combat strike mission in the first hours of the Gulf War in January, 1991. When the war ended, the Iraqi Government returned a "soft tissue fragment and hair bearing skin" which allegedly related to Lt. Cmdr. Speicher. However, subsequent DNA tests determined the remains were not those of Lt. Cmdr. Speicher.

The Navy convened a Status Review Board on May 20, 1991 to consider the state of evidence at that time related to Lt. Cmdr. Speicher's loss. On May 22, 1991, the late Admiral Mike Boorda, then Chief of Naval Personnel, approved and signed out the board-recommended "finding of death" which resulted in Lt. Cmdr. Speicher's status being changed from missing in action to killed in action.

In December, 1993, a Qatari official and his hunting party came upon Lt. Cmdr. Speicher's aircraft wreckage in Iraq. He immediately forwarded to U.S. military officials pictures of the plane's canopy, a shard of metal with serial numbers, and passed on his recollection of having seen the ejection seat as well. Two years later, in December, 1995, U.S. crash site specialists from the Department of Defense were permitted to access the crash site, following coordination efforts between the Iraqi Government and the International Committee of the Red Cross. The results of the crash-site investigation were briefed to the Congress in the winter and spring of 1996. In December, 1997, we were further briefed on this matter by the Principal Deputy Assistant Secretary of Defense for International Security Affairs, Frederick Smith, in response to concerns generated by the attached *New York Times* story.

100-247199-1002 JCS LEGISLATIVE AFFAIRS 100 697 0255 P.03/05

The Honorable Richard Danzig
March 19, 1999
page 2

In February, 1998, a classified follow-up briefing on this case was provided to the Senate Select Committee on Intelligence by the Department of Defense POW/Missing Personnel Office (DPMO). In September, 1998, pursuant to our earlier inquiries on this matter, the Intelligence Community and the Department of Defense provided to the Senate Select Committee on Intelligence a classified chronology outlining Intelligence Community activities bearing on the issues raised as a result of Lt. Cmdr. Speicher's loss. The briefing materials and the chronology referenced above are available for your review. We *strongly* believe that the information contained therein supports the request we are making of you with this letter.

During the last three years, we understand that the Department of Defense has refused to authorize any further approaches to the Iraqi Government concerning the fate of Lt. Cmdr. Speicher "because of the state of U.S.-Iraqi relations." Nonetheless, our offices were informed during a briefing we received on March 12, 1999 that the official publicly-stated position of the Department of Defense POW/Missing Personnel Office (DPMO) with respect to whether the available evidence indicates Lt. Cmdr. Speicher perished in his aircraft incident, is "*we don't know*." As you know, the DPMO is charged with developing, implementing, and overseeing policy on unaccounted for U.S. personnel for the Department of Defense.

In view of the official position of the Department of Defense and the classified evidence now available to the Department of the Navy, we believe that the justification for the finding of death determination in May, 1991, is no longer valid and conclusive. We, therefore, urge you to use your statutory authority to change the status of Lt. Cmdr. Speicher back to "missing in action" -- a status that more accurately reflects the available evidence and provides a presumptive "benefit of the doubt" to Lt. Cmdr. Speicher. We owe nothing less to Lt. Cmdr. Speicher and his family.

We look forward to your response, and thank you for your personal attention to this very important matter that deeply concerns us.

Sincerely yours,

BOB SMITH, U.S.S.

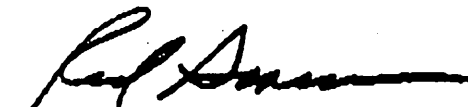
ROD GRAMS, U.S.S.

Horn, John R.

From: Pasquerella, Robert T.
Sent: Wednesday, September 02, 1998 2:18 PM
To: Man, Gregory K. S.
Cc: Liotta, J. Alan; Sydow, C. Gary
Subject: DESERT STORM LOSSES

Attached is a summary of Desert Storm losses for servicemen whose status is KIA-BNR. V/r, Bob



iraq_losses.doc

2 September 1998

MEMORANDUM FOR DASD POW/MPA

From: LT Robert T. Pasquerella, USN

Subj: STATUS OF OPERATION DESERT STORM LOSSES (KIA-BNR)

1. Speicher, Michael S., LCDR, USN F-18 17 Jan 91 KIA-BNR

On 17 January 1991, LCDR Speicher was shot down over Iraq while flying a suppression of enemy air defense (SEAD) mission west of Baghdad. At 0352 hours, another pilot operating in the vicinity of LCDR Speicher's loss location reported observing an explosion he described as an aircraft being hit by an air-to-air missile. He estimated the position and altitude as 3300N 04220E and 24,000 feet. Reporting indicates a MIG-25 FOXBAT active in the area at the time of this incident. No radio calls or beepers were heard and no signals were observed.

Upon completion of the strike group's mission, search and rescue (SAR) forces were alerted and possible divert airfields were contacted with negative results. LCDR Speicher's crash site was not located prior to termination of Operation Desert Storm. Upon termination of combat operations in Iraq, the Government of Iraq returned remains purportedly associated with LCDR Speicher were turned over to U.S. Government control. These remains were later determined not to correlate to LCDR Speicher through blood typing and DNA analysis. Following up on a lead obtained through intelligence sources, LCDR Speicher's crash site was located in April 1994. An ICRC team excavated this crash site at 330114N 0421528E in December 1995.

During the excavation, wreckage associated with LCDR Speicher's aircraft was discovered. The team noted a large backfill pile present in the area where the cockpit would have been located, indicating a previous unilateral excavation. In addition, the team discovered a U.S. NOMEX flight suit approximately 3.5 kilometers northeast of the crash site. The flight suit was lying on the surface with minimal evidence of weathering and minimal adherent soil. The team also discovered pilot life support equipment and a 20mm shell approximately 1 kilometer east of the flight suit. The condition of flight suit and pilot related materials, the method in which they were found, and the presence of the 20mm shell indicate that these items may not have originated where they were recovered.

Material analysis of the aircraft wreckage indicates a catastrophic event occurred in the forward part of the aircraft resulting in a power loss and a short duration fire. Indications are that LCDR Speicher then jettisoned the canopy, possibly during the ejection sequence. Analysis of the flight suit and life support equipment indicates these items were cut off the pilot. The condition of the flight suit and life support equipment, the pilot was probably severely injured or dead when these items were removed.

2. Bland, Thomas C., 1Lt, USAF	AC-130	31 Jan 91	KIA-BNR
Blessinger, John P., SSgt, USAF			KIA-BNR
Buege, Paul G., MSgt, USAF			KIA-BNR
Clark, Barry M., Sgt, USAF			KIA-BNR
Galvin, Arthur, Capt, USAF			KIA-BNR
Harrison, Timothy R., Sgt, USAF			KIA-BNR
Hodges, Robert K., TSgt, USAF			KIA-BNR
May, James B., MSgt, USAF			KIA-BNR
Oelschlager, John L., SSgt, USAF			KIA-BNR
Weaver, Paul J., Maj, USAF			KIA-BNR

During the early morning hours of 31 January 1991, the above listed individuals departed King Fahd Airport on a combat mission over northern Saudi Arabia and southern Kuwait. While flying their designated route, the AC-130 (call sign Spirit 03) was tasked to attack a Free Rocket over Ground (FROG) site. At 0624, AWACS personnel heard a weak distress call, but received no reply to a radio check with Spirit 03. The distress call was also heard by another pilot in the area. AWACS' last radar fix on Spirit 03 was along the Kuwaiti coast, near the Saudi border at 2844N 4816E.

SAR and reconnaissance forces in the area were tasked to conduct an extensive search of the area, but found nothing. No emergency beacons were heard nor was voice contact made after the initial mayday call. Attempts to locate the aircraft continued throughout the conflict, both over water and ashore. On 4 March 1991, following the liberation of Kuwait, search crews finally located the aircraft's wreckage on the edge of the continental shelf just off the coast of Kuwait. On 5 March, divers retrieved partial remains of several crewmen not listed above. Following a review of available information, the Wing Commander concluded there were no survivors.

Additional remains were not recovered because of the condition and location of the aircraft's wreckage. The aircraft had broken apart causing open access to free flowing water and half the wreckage fell off the continental shelf into extremely deep water. The U.S. Government has received no indication that any of the crewmembers survived the loss incident. There have been no recent attempts to recover additional remains. No new information has been reported on this incident since the initial group of remains was recovered.

3. Cooke, Barry T., LCDR, USN	A-6	2 Feb 91	KIA-BNR
-------------------------------	-----	----------	---------

On 2 February 1991 LCDR Cooke and was flying an armed surface reconnaissance mission near Faylaka Island in the northern Persian Gulf when his A-6, call sign Heartless 531, was engaged by AAA and surface-to-air missiles. After successfully evading the threat, Heartless 531 began what appeared to be an attack run on a small Iraqi patrol boat just west of Faylaka Island. Shortly thereafter, radar and radio contact was reported lost and SAR mission was initiated. Immediate SAR activity resulted in the location of a 400 gallon fuel tank, oil/fuel slick, and disturbed water. No radio signals or emergency beepers were heard, and no parachutes were sighted. Two small Iraqi patrol

boats were in the general vicinity, but air cover prevented them from approaching within two miles of the probable impact site.

Active search for survivors was terminated at dusk on 3 February, and a salvage crew was requested to dive on site. However, high threat from sea mines precluded a surface approach to the loss site. On 9 February, a portion of the A-6's tail with call sign letters AJ was located; still no indication of any survivors. In mid-February, upon recovery of remains, the status of LT Cooke's bombardier-Navigator was changed from MIA to KIA. Presumptive finding of death was based on known details of the loss incident, lack of enemy forces in the area, lack of radio or emergency beacons, status of the other crewman, and the lack of sightings in captivity by Allied returnees. No new information has been reported on this loss incident in recent years.

4. Dwyer, Robert J, LT, USN F-18 5 Feb 91 KIA-BNR

On 5 February 1991, LT Dwyer was returning from a night strike mission over Iraq. LT Dwyer proceeded to the coast, and was in constant radio contact with his wingman. After going feet wet approximately 25 miles southeast of Faylaka Island at an altitude of 30,000 feet, LT Dwyer passed on his estimated bomb damage assessment to an orbiting E-2. Radio contact was lost shortly thereafter.

Investigation revealed that although LT Dwyer was out of radio contact, he continued in a direct route back to the USS THEODORE ROOSEVELT. The USS LETYE GULF radar track of LT Dwyer's aircraft indicated a rapid decent from 25,000 feet to zero feet. The impact point was approximately 275348N 0503455E, approximately 80 miles from the USS Roosevelt. Voice communications were never reestablished and no emergency beepers were heard. Investigators could find no indication that LT Dwyer ejected from his aircraft.

An extensive SAR effort utilizing both surface ships and aircraft was launched shortly after contact was lost with LT Dwyer. This effort was terminated 70 hours later without success. SAR effort failed to locate either LT Dwyer or his aircraft. A check of nearby airfields was conducted with negative results.

Horn, John R.

From: Pasquerella, Robert T.
Sent: Monday, May 11, 1998 11:36 AM
To: Wilson, Kevin J.
Cc: Man, Gregory K. S.; Sydow, C. Gary
Subject: LOCATING INFO FOR SPEICHER

Classification: ~~SECRET~~

Sir,

The below informaiton will assist in the effort to identify the cause of LCDR Speicher's shutdown. I recommend reviewing the imagery within a 25NM radius of the crash site located in 1994 at 330114N 0421528E (UTM 38S KB 43810 56910).

On 17 January 1991, LCDR Speicher was the pilot of an F/A-18 conducting a SEAD mission west of Baghdad, Iraq when he was shot down. Data retrieved from the Memory Data unit recovered at the crash site indicates the aircraft experienced an abrupt power loss at 3:49:59.75C. This was probably when the aircraft was shot down. At this time, the aircraft was at an altitude of 27,872 feet, heading 001.4 degrees at 368 knots. At 0352C hours, another aircrew in the vicinity reported observing an explosion he described as an aircraft being hit by an air-to-air missile. He estimated the position as 3300N 04220E and the altitude 24,000 feet. The Crash site was located in 1994 at 330114N 0421528E (UTM 38S KB 43810 56910). The most likley scenario is that LCDR Speicher was shot down by an AAM launched from a MIG-25 Foxbat; however, it is also possible he was shot down by an SA-6 SAM fired from an unidentified location.

V/r,
Bob

Classification: ~~SECRET~~

(b) (1)
1.5 (c)

Horn, John R.

From: Wilson, Kevin J.
Sent: Tuesday, March 10, 1998 1:09 PM
To: Pasquerella, Robert T.
Subject: Further Definition

CLASSIFICATION: ~~SECRET~~

Bob,

Mr. Liotta liked the overall package. Couple of things. He wants to be more specific on areas of interest. Please look at the following three items and try to be more definitive on the area. Thanks.

1. LCDR Speicher is suspected of being shot down by an air-to-air missile fired from an Iraqi aircraft or by a surface-to-air missile fired from an unidentified anti-aircraft battery. Provide any records that relate to the shoot down of coalition aircraft on 17 January 1991.

2.

~~_____~~
~~_____~~
~~_____~~

(b)(1) 1.5(c)

3. Air Defense and/or Republican Guard units were most likely active in the area of LCDR Speicher's loss location. Identify and make available for interview any individuals from Air Defense or Republican Guard units in the area at the time of the loss that may have information pertaining to this incident or LCDR Speicher fate.

CLASSIFICATION: ~~SECRET~~

DESERT STORM – SPEICHER CASE

QUESTIONS & ANSWERS

February 18, 1998

Q1: How many U.S. personnel remain unaccounted for from the Gulf War?

A1: There are no U.S. service personnel listed as unaccounted for from the Gulf War. At the end of hostilities, the U.S. negotiated the release of 23 service personnel who were captured during the conflict. Another 26 service personnel were killed in action, 13 of which remains were recovered. Of the 13 personnel whose bodies were not recovered, 12 are over-water losses.

Q2: How many pilots were shot down on 17 January 1991?

A2: A total of five individuals from three aircraft were shot down on 17 January 1991. The five individuals are LCDR Speicher, USN, LT Wetzel, USN, LT Zaun, USN, Maj. Holland, USAF, and Maj. Koritz, USAF. LCDR Speicher was the pilot of an F/A-18 FROM THE USS SARATOGA and his current status is Killed in Action, Body not Recovered. LT Zaun and LT Wetzel were the crew of an A-6 from the USS THEODORE ROOSEVELT and were both released at the end of the Gulf War conflict. Maj. Holland and Maj. Koritz was the crew of an F-15 and are listed as Killed in Action, Body recovered.

Q3: How many aircraft from USS SARATOGA were shot down?

A3: Two aircraft from the USS SARATOGA were shot down during Operation Desert Storm. The F/A-18 piloted by LCDR Speicher and an F-14 shot down on 21 January 1991. The pilot, LT Jones, USN, was rescued by SAR forces; however, the Radar Intercept Officer, LT L.R. Slade, USN, was captured by Iraqi forces and later repatriated.

Q4: Was the hearsay report by the former Joint Rescue Coordination Center Commander on 21 April 1994 regarding possible communications (i.e. two clicks) on the Guard frequency between a Navy E-2 and a possible downed aircrew investigated?

A4: DPMO analysts determined the hearsay report was not related to the LCDR Speicher's loss incident. On 18 January 1991, an USAF RC-135 reported a beacon at 1721Z and a Navy E-2 reported in communication with "404" on guard. "404" was an A-6 shot down on 18 January 1991. This incident most likely correlates to the above report.

Q5: What actions did the intelligence community take to account for LCDR Speicher from 1991-1993?

A5: Attempts were made to locate LCDR Speicher's crash site through imagery analysis. These efforts were unsuccessful. In addition, former POWs were debriefed following their release. (One returnee stated he was asked if the USS SARATOGA lost any aircraft. The PW told the interrogator an A-6 and an F-18 were lost. The interrogator then asked if the PW knew the F-18 pilot. When the PW answered in the negative, the interrogator stated "well he's dead.") DIA (PW/MIA) personnel continued to monitor incoming message traffic for any additional information with possible correlation's to Gulf War losses.

Q6: On 4 March 1991, U.S. officials were advised that a recently recovered Kuwaiti intelligence officer reported the observation of an American pilot in an Iraqi military hospital. The sighting reportedly took place about 15 days earlier when the intelligence officer was being held captive in the vicinity of An Nasiriyeh, Iraq. Could this sighting be correlated to LCDR Speicher?

A6: Information provided by the Kuwaiti officer does not correlate to any known American loss incident. A review of allied losses found one possible correlation. On 19 January 1991, a British Tornado with two crewmen aboard was shot down over An Nasiriyeh. Both crewmen were injured during the ejection sequence and required medical attention. One of the crew, Flight Lieutenant Stewart, was treated at a roadside medical facility for about 15 minutes then taken to a nearby military installation where he was placed in a pick-up truck and taken to Basrah. Flight Officer Waddington sustained more severe injuries and was taken to a nearby hospital where his separated shoulder was reset and facial lacerations were cleaned. Waddington did not observe any other prisoners, Allied or otherwise, at the hospital. After treatment, Waddington was taken to a nearby military installation where he waited for transportation to Baghdad.

Two factors mitigate against a clear correlation to the two British pilots. First, the Kuwaiti intelligence officer stated the observation took place 15 days prior to his debrief which occurred in early March. This would place sighting in mid-February, almost a month after the British loss incident. Second, neither pilot spent much time in Iraqi medical facilities or in the vicinity of An Nasiriyeh, significantly reducing the possibility a Kuwaiti prisoner observed them. Furthermore, Waddington also stated he saw no other prisoners in the hospital. It is possible the Kuwaiti is reporting hearsay information as firsthand.

An Nasiriyeh is located over 230 miles southeast of LCDR Speicher's crashsite. Based on known Iraqi POW handling procedures, LCDR Speicher would not have been taken to An Nasiriyeh. All Allied pilots shot down and captured west of Baghdad were transported along the East-West Highway directly to Baghdad where they remained until release. In addition, if one were to consider the military situation on 19 January 1991, the Iraqi Government would not have attempted to transport an American prisoner from western Iraq or Baghdad to An Nasiriyeh which is located on one of the two primary avenues of approach being used by Allied forces in their attack.

Horn, John R.

From: Rosenau, David M.
Sent: Wednesday, February 18, 1998 12:21 PM
To: Wilson, Kevin J.; Pasquerella, Robert T.
Cc: Man, Gregory K. S.; Sydow, C. Gary
Subject: RE: INTEL EFFORTS 1991-1993

Bob,

Believe it would be accurate to say DIA-PW/MIA personnel (me) continued to monitor incoming message traffic for any additional information. Copies of pertinent information were maintained.

From: Pasquerella, Robert T.
Sent: Wednesday, February 18, 1998 11:27 AM
To: Wilson, Kevin J.; Rosenau, David M.
Cc: Man, Gregory K. S.; Sydow, C. Gary
Subject: INTEL EFFORTS 1991-1993

Dave - please make any additions you think are relevant.

Q: What actions did the intelligence community take to account for LCDR Speicher from 1991-1993?

A: Attempts were made to locate LCDR Speicher's crash site through imagery analysis. These efforts were unsuccessful. In addition, former POWs were debriefed following their release. One returnee stated he was asked if the USS SARATOGA lost any aircraft. The PW told the interrogator an A-6 and an F-18 were lost. The interrogator then asked if the PW knew the F-18 pilot. When the PW answered in the negative, the interrogator stated "well he's dead."

Horn, John R.

From: Rosenau, David M.
Sent: Wednesday, February 18, 1998 9:22 AM
To: Man, Gregory K. S.
Cc: Sydow, C. Gary; Wilson, Kevin J.; Caswell, James R.; Pasquerella, Robert T.; Richmond, Jr., Melvin E.; Travis, Jo Anne
Subject: An Nasiriyeh Sighting

Greg,

Per Alan's request for an analysis of the An Nasiriyeh sighting, the following is submitted. If you have no problems, please forward to Allan with a CC to Joe. R



Speichr3

An Nasiriyeh Sighting

Report

On 4 March 1991, U.S. officials were advised that a recently recovered Kuwaiti intelligence officer reported the observation of an American pilot in an Iraqi military hospital. The sighting reportedly took place about 15 days earlier when the intelligence officer was being held captive in the vicinity of An Nasiriyeh, Iraq. Note: DPMO was advised of the report in August 1994. end note

Analysis

Information provided by the Kuwaiti officer does not correlate to any known American loss incident. A review of Allied losses found one possible correlation. On 19 January 1991, a British Tornado with two crewmen aboard was shot down over An Nasiriyeh. Both crewmen were injured during the ejection sequence and required medical attention. One of the crew, Flight Lieutenant Stewart, was treated at a roadside medical facility for about 15 minutes then taken to a nearby military installation where he was placed in a pick-up truck and taken to Basrah. Flight Officer Waddington sustained more severe injuries and was taken to a nearby hospital where his separated shoulder was reset and facial lacerations were cleaned. Waddington did not observe any other prisoners, Allied or otherwise, at the hospital. After treatment, Waddington was taken to a nearby military installation where he waited for transportation to Baghdad.

Two factors mitigate against a clear correlation to the two British pilots. First, the Kuwaiti intelligence officer stated the observation took place 15 days prior to his debrief which occurred in early March. This would place sighting in mid-February, almost a month after the British loss incident. Second, neither pilot spent much time in Iraqi medical facilities or in the vicinity of An Nasiriyeh, significantly reducing the possibility they were observed by a Kuwaiti prisoner. Furthermore, Waddington also stated he saw no other prisoners in the hospital. It is possible the Kuwaiti is reporting hearsay information as firsthand.

An Nasiriyeh is located over 230 miles southeast of LCDR Speicher's crashsite. Based on known Iraqi POW handling procedures, LCDR Speicher would not have been taken to An Nasiriyeh. All Allied pilots shot down and captured west of Baghdad were transported along the East-West Highway directly to Baghdad where they remained until release. In addition, if one were to consider the military situation on 19 January 1991, the Iraqi Government would not have attempted to transport an American prisoner from western Iraq or Baghdad to An Nasiriyeh which is located on one of the two primary avenues of approach being used by Allied forces in their attack.

Conclusion

The Kuwaiti intelligence officer did not see LCDR Speicher.

Chap 76, Sec. 1501-1 Title 10 USC	Facts pertaining to LCDR Michael S. Speicher, USN
--------------------------------------	---

Day of loss	Commander (CO) of Unit, Facility, or Area of Missing Person (MP) Assigned Responsibilities	
1st day	<ul style="list-style-type: none"> CO conducts an assessment to determine if disappearance may be involuntary. 	<ul style="list-style-type: none"> LCDR Michael Scott Speicher was part of a strike group from the USS Saratoga tasked with suppressing enemy air defenses approximately 40 miles west of Baghdad. TOT was 0050Z and Speicher failed to show up for his tanking at 0140Z. Upon return from the mission, Speicher's wingman reported that prior to reaching their target, several air and ground explosions occurred. No communications or distress beacons were reported.
Any time	<ul style="list-style-type: none"> If the CO's preliminary assessment concludes that the person is missing, the CO shall recommend that the person be placed in a missing status. 	<ul style="list-style-type: none"> Unit CO released initial Personnel Casualty report at 2038Z, 17 Jan declaring LCDR Speicher DUSTWIN (Duty Status, Whereabouts Unknown).
NLT 10 days	<ul style="list-style-type: none"> CO transmits a report containing that recommendation to the Service Secretary concerned. An Advisory copy goes to the theater component commander with jurisdiction over the MP. 	<ul style="list-style-type: none"> After sufficient time for an investigation, the Unit CO released the findings of his investigation on 25 Jan recommending Speicher's status remain as MIA. Status was based on inability to positively confirm wingman's report was indeed Speicher's aircraft being shot down and the lack of an identifiable crash site.
Status	Missing NLT day 10	

	Service Secretary Responsibilities	Service Secretary Responsibilities
NLT 10 days of receipt of CO's report	<ul style="list-style-type: none"> Upon receiving information the Secretary shall appoint an initial Board of Inquiry consisting of: <ul style="list-style-type: none"> Military Officer with respect to a member of the armed forces or a civilian with respect to a civilian employee Counsel for MP. Counsel to advise board on procedures. Access to all information Proceedings Closed 	<ul style="list-style-type: none"> Jan 17 - Due to CNN reporting, SecDef Cheney identified the first American casualty of the Gulf War as LCDR Michael S. Speicher, listing him as Missing in Action because his body was not recovered after he was shot down in his F/A-18 {AP, Jan. 18 1991} Mar 20 - Iraqis turn over remains (1.5 pounds of flesh) with a death certificate to the ICRC identifying them as belonging to the U.S. pilot by the name of "Michael." March 28, 1991 - Iraqi delegation to the third session of the Tripartite Commission agreed to provide a witness statement concerning questionable identification of partial remains of one MIA, reportedly LCDR Speicher.
NLT 30 days of Board appointment	<ul style="list-style-type: none"> The Board shall submit a report which recommends MP be placed in a missing status or change to AWOL, Deserted, or Dead (subject to reqmts of Sec. 1507) MP Counsel issues independent review of report. 	<ul style="list-style-type: none"> April 2, 1991 - Comment made by an Iraqi interrogator to a American POW - "POW was asked if USS Saratoga lost any aircraft. POW said yes, a F-18 and an A-6. Source was asked if he know the pilot of the F-18. Source replied No. The interrogator was upset, as he believed the airwing was a tight-knit family and POW should know the pilot. The interrogator stated, "Well, he's dead."
NLT 30 days of Board's Report	<ul style="list-style-type: none"> Secretary concerned reviews the Board report and upon determination that it is complete, shall make a determination of status of the MP, including whether MP is declared missing, AWOL, Deserted or Dead. 	<ul style="list-style-type: none"> May 22, 1991 - SecNav changed casualty status of LCDR Speicher to KIA for administrative purposes from MIA. Date of death established as Jan 17, 1991.
NLT 30	<ul style="list-style-type: none"> Secretary shall take reasonable 	

	Chap 76, Sec. 1501-1 Title 10 USC	Facts pertaining to LCDR Michael S. Speicher, USN
--	--------------------------------------	---

days of Sec's Determination	actions to provide a report to primary next of kin, other members of the immediate family and any other previously designated person of the MP an unclassified summary of the unit commander's report and the report of the Board.	
1 Yr from Board Report Date	<ul style="list-style-type: none"> • Board report may be made to the public. 	<ul style="list-style-type: none"> • Oct 16, 1991 at the sixth Tripartite Commission session chaired by the ICRC, BG Fratarangelo told the commission that all 47 Americans who had been listed as missing now have been accounted for, but that the U.S. still wanted to recover the remains of LCDR Speicher and LCDR Cooke. Fratarangelo expressed U.S. difficulty in reconciling Iraqi statements about missing coalition members with available evidence.
Status	Missing day 1 or status changed NLT day 70	

	<u>Service Secretary Responsibilities</u>	<u>Service Secretary Responsibilities</u>
Any time up to 1 YR of initial report on MP.	<ul style="list-style-type: none"> • Forms a board - If information becomes available <u>that might change status</u> (missing/AWOL/deserter/dead) • Same Procedures as Follow on Reviews. 	
Follow on reviews	<ul style="list-style-type: none"> • Convenes a board every three years from time of loss, until 20 years after loss; or anytime new information may result in change of status. • Officer or civilian of same experience/expertise(case dependent) • Counsel on board • Other officer or civilian (case dependent) • Counsel for <u>each</u> Missing Person • Pres. access to all information • Open to immediate family, primary next-of-kin, dependents, designated person. shall be given: <ul style="list-style-type: none"> * 60 day notice, 21 days to respond. * Access to all unclas records, * Opportunity to present information, * opportunity to object to board report. * Primary next of kin or previously designated person may attend with private counsel. 	<ul style="list-style-type: none"> • Nov 19, 1993 - ICRC provided a note dated Oct 14, 1993 from the Iraqi's stating that no additional information is available concerning LCDR Speicher and LCDR Cooke. The note stated, "Regarding the Lt. Commander (Captain Pilot?) Michael S. Speicher. His name was reported by his colleague pilot Robert James who was held in the same day and was repatriated home through your esteemed delegation on March 5, 1991. No additional information is available about him in spite of the investigation and tracing." (1Lt Robert James Sweet, USAF, A-10 pilot, captured Feb 2, 1991 and released March 5, 1991 made no statements about LCDR Speicher to the Iraqi's during internment.) • Dec 19, 1993 - During a meeting with USLO, Doha, Qatar Asist. Chief of Staff of Operations, Training and Planning to Iraq turned over pictures and a piece of wreckage from a crashsite in Iraq he gathered while hunting there. • Dec 9, 1995 - ICRC Investigation Team excavates crash site in Iraq. • Feb 16, 1996 - SECDEF informed that material recovered from crash site is insufficient to determine fate of pilot. • Oct 2, 1996 - SECNAV modified presumptive finding of death date from May 22, 1991 to September 30, 1996 based on recent information supporting a presumptive finding of death and retention in a KIA status, which was also in accordance with the widow of LCDR Speicher's wishes.

<p>Follow on Reviews (cont)</p>	<ul style="list-style-type: none"> • Board results may be invalidated by failure to locate one of the above individuals. • Board recommends continuation of missing status or change. May not change to dead unless: <ul style="list-style-type: none"> * Proof of death, and * credible evidence exists person is dead * no credible evidence exists person is alive, * good faith effort made to search loss site and enemy archives. • NLT 30 days after board SecDef determines if status should be changed. NLT 90 days provide report to family 	
<p>Appeals of current actions</p>	<ul style="list-style-type: none"> • Review by US court of appeals upon petition by family/previously designated person that finding of death be set aside. If set aside, above parties may request Secretary to form a new board. 	
<p>Appeals of past actions.</p>	<ul style="list-style-type: none"> • NLT 2 years after Act approval, dependent/immediate family may request a board review of any person previously declared dead with no limit on: <ul style="list-style-type: none"> * How long ago (WW I maybe) * Where or how loss occurred. • Whenever information that would directly lead to change in status becomes available board is established. 	

Lieutenant Commander Michael Speicher

Commander Speicher was lost in combat during Operation Desert Storm when his F/A-18 aircraft was downed over Iraq. The Secretary of the Navy, based on the information known to him at the time, assigned Commander Speicher's casualty status as killed in action/body not recovered. The Department of the Navy continues to carry him in this status today because it reflects the most accurate information to date regarding his fate. However, given America's unwavering commitment to obtain the fullest possible accounting for our sons and daughters lost due to hostile action, the case was never officially closed. The discovery of intelligence information several years after the loss incident provided our first new clues and allowed us to begin an aggressive investigation. Since 1993, we have used all appropriate analytical, diplomatic, intelligence and scientific means available to mount a comprehensive investigation.

In December 1995, working through the International Committee of the Red Cross, investigators from the Navy and the Army Central Identification Laboratory in Hawaii entered Iraq, with the permission of the Iraqi government, and conducted a thorough investigation of Commander Speicher's crash site. Although we did not recover his remains at the crash site, information and aircraft wreckage was removed that allowed us to continue our investigation.

Additionally, Commander Speicher's family has been kept fully informed of the Department's efforts and the information we have has been shared with the family. The family has publicly expressed their satisfaction with the Department's actions, and also requested that the Department keep the information classified until the case is resolved to protect their privacy and the integrity of any potential new lead.

Dear Mr. Parker:

Thank you for your e-mail correspondence concerning the case of Lieutenant Commander Michael Scott Speicher. In responding to several of your points, I think it necessary to correct many of your misperceptions about this case, no doubt as a result of your reading of newspaper accounts.

Commander Speicher was lost in combat during Operation Desert Storm when his F/A-18 aircraft was downed over Iraq. The Secretary of the Navy, based on the information known to him at the time, assigned Commander Speicher's casualty status as killed in action/body not recovered. The Department of the Navy continues to carry him in this status today because it reflects the most accurate information to date regarding his fate. However, given America's unwavering commitment to obtain the fullest possible accounting for our sons and daughters lost due to hostile action, the case was never officially closed. The discovery of intelligence information several years after the loss incident provided our first new clues and allowed us to begin an aggressive investigation. Since 1993, we have used all appropriate analytical, diplomatic, intelligence and scientific means available to mount a comprehensive investigation.

In December 1995, working through the International Committee of the Red Cross, investigators from the Navy and the Army Central Identification Laboratory in Hawaii entered Iraq, with the permission of the Iraqi government, and conducted a thorough investigation of Commander Speicher's crash site. Although we did not recover his remains at the crash site, information and aircraft wreckage was removed that allowed us to continue our investigation.

Additionally, Commander Speicher's family has been kept fully informed of the Department's efforts and the information we have has been shared with the family. The family has publicly expressed their satisfaction with Department's actions, and also requested that the Department keep the information classified until the case is resolved to protect their privacy and the integrity of any potential new lead.

I understand your concern about resolving the fate of Commander Speicher. Certainly no one feels a stronger commitment than I do to do everything possible to fulfill the American promise to our servicemen and women. We will not rest until we bring them home.

Sincerely,

William J. Clinton

ANALYSIS OF GROUND MARK NOTED NEAR GULF WAR CRASH SITE

- In April 1994, while reviewing overhead imagery of a U.S. F/A-18 crash site in western Iraq, intelligence analysts identified what they believed to be a possible man-made ground symbol drawn in the desert sand.
- Research into a possible association between the ground marking and the F/A-18 pilot, LCDR Michael Scott Speicher (KIA-BNR), was conducted. Further analysis concluded that the marking did not correlate to LCDR Speicher.

-The U.S. Navy search and rescue (SAR) instructions (ie – Letter of the Week/Word of the Day) that LCDR Speicher would have received and been expected to employ, are not consistent with the ground marking observed. In addition, the environmental conditions in the area (high winds/shifting sands), coupled with the three year time difference between LCDR Speicher's crash and the appearance of the ground mark on imagery, further rules out the possibility of a correlation.

-During the 1995 International Committee of the Red Cross (ICRC) visit to the LCDR Speicher's crash site, team investigators searched the entire vicinity and noted nothing they considered to be any type of survival symbol.

-Defense Intelligence Agency (DIA) analysts noted that Iraqi military units routinely draw designs in the desert sand during training exercises. The site of the unidentified marking is in the general vicinity of an Iraqi military training area. The marking could not be associated however, with any known Iraqi military unit.

-Analysts believe the ground marking may have been caused by tire tracks left by some unidentified vehicle. Subsequent reviews of area imagery indicated that the location is used as an occasional camping site. Motorized vehicles have been noted in this area.



DEFENSE PRISONER OF WAR/MISSING PERSONNEL OFFICE
2400 DEFENSE PENTAGON
WASHINGTON, DC 20301-2400

In reply refer to:
I-97/21681

MEMORANDUM FOR The International Committee Of The Red Cross (ICRC)
(Operations Division, Attn: Michelle Cageneaux)

FROM: Deputy Assistant Secretary of Defense for POW/Missing Personnel Affairs
Prepared by LCDR K. Wilson, OASD/ISA-DPMO

SUBJECT: Results of the Investigation of U.S. F/A-18 Loss in Western Region of Iraq

Purpose. For your benefit and that of the Iraqi personnel who assisted us on the humanitarian operation to confirm the fate of LCDR Michael S. Speicher, this report provides a status of findings from the excavation of his crash site.

Background

On January 16, 1991 at 0136 hours, LCDR Speicher launched in the first attack wave associated with Operation Desert Storm. At approximately 2 hours and 15 minutes into the mission, LCDR Speicher's wingman reported seeing an explosive flash in the vicinity of Speicher's F/A-18 aircraft. The U.S. Government has yet to determine the fate of LCDR Speicher, and to return him or his remains to his family.

In March 1991, the Republic of Iraq (ROI) repatriated remains to the U.S. that they associated with the name of "Michael". DNA analysis subsequently determined they were not those of LCDR Speicher.

On March 1, 1995, the ROI agreed to a joint ICRC/ROI humanitarian recovery effort to determine the fate of the pilot. The team included experts from the U.S. Central Identification Laboratory in Hawaii (CILHI). On December 10, 1995, a team of ICRC officials and CILHI personnel traveled to the suspected crash site to begin a recovery operation for the remains of LCDR Speicher. The crash site was located in the vicinity of Tulul Ad Dulaym, Wadi Thumayl, Republic of Iraq.

Description of Crash Site

The field investigation was conducted on December 10 - 16, 1995. Wreckage of the F/A-18 aircraft was discovered within three hours driving time southwest from Baghdad. The mishap site was located less than 30 kilometers to the south of a major East-West highway in a desert region with no substantial natural landmarks. Several Bedouin camps were visible to the north and northwest of the crash site, with numerous dirt trails radiating out from the camps to the paved roads.

Large fragments of recognizable aircraft wreckage were present on the desert floor (photos 1-3, enclosure 5). As there was no significant crash crater and the aircraft wreckage showed minimal fragmentation, it was determined to be consistent of a terminal velocity, high angle and low power impact. The wreckage consisted of the nose gear and 20mm gun, representing the nose of the aircraft; the wings; engines; and tail rudders and stabilizers (enclosure 3). Ordnance was still located at the crash site (photo 13, enclosure 5). The following major components were not with the airframe:

- 1) Wing fuel drop tank - found 4000 meters north
- 2) Center line fuel drop tank - found 2500 meters north
- 3) Canopy - found 670 meters northeast
- 4) The entire cockpit and instrument bay section, forward of the wings to just aft of the gun - not found

Subsequent post crash fire and erosion had contributed to the breakdown and disintegration of the structural elements manufactured from composite material, such as the wings.

Aircraft Wreckage Findings

Excavation was initiated in the area of the cockpit, an area which showed signs of recent manual digging. The ground was excavated to a depth of 50 centimeters to culturally sterile soil. Excavation continued along the aircraft's midline until it became apparent that no significant cockpit debris, pilot-related materials, or human remains were present (photos 4-9, enclosure 5).

Analysis of the engines concluded that both engines were in relatively good shape. Based on post crash analysis of the photographs of engine components, the qualified assumption is the engines had shut down in flight. The wing and centerline drop tanks found north of the crash site had their pylons still attached (photos 10-11, enclosure 5). The pylons were torn from the fuselage inflight, indicative of excessive aerodynamic forces over a short period of time that were consistent with the aircraft being subject to a violent spin.

The cockpit canopy, found northeast of the wreckage, had been jettisoned. When first examined, the frame was standing vertically on a small rise where it apparently had been placed by the Bedouins to serve as a local landmark (photo 12, enclosure 5). Both canopy jettison rocket motors had been fired, which produced burn marks even and complete. Given available evidence, mishap investigators determined that the pilot initiated the jettison.

Archaeological Findings

During the recovery effort, the team surveyed a circle of approximately 10 kilometers in diameter centered around the crash site. The team anthropologist shovel-tested several low rock piles located around the wreckage in search of a possible grave site (photo 14, enclosure 5). None appeared to be associated with a subsurface disturbance within the last ten years. No human remains were recovered at either the crash site or the several small stone piles examined. No pilot-related materials were recovered at the crash site. Cockpit-related items found during excavation consisted of only two switches and one warning indicator light.

During the excavation, Iraqi officials present at the site notified the team that a young Bedouin boy had encountered a flight suit while herding his sheep. Several team members traveled to a small rise approximately 3.5 kilometers northeast of the crash site and discovered a U.S. flight suit lying on the surface. The team began to systematically surface search the adjoining desert, but were not allowed to directly interview the child. Ultimately, additional pilot-related materials were recovered approximately 1 kilometer to the east of where the flight suit was located:

- 1) Six fragments of anti-G suit material
- 2) An ejection-seat upper-leg garter fragment
- 3) Three survival-raft fragments
- 4) A survival-kit flare
- 5) A parachute-riser fragment

Final Analysis

The flight suit is consistent with the one worn by LCDR Speicher. Pieces of the Aviation Life Support System (ALSS) equipment found suggest that LCDR Speicher ejected from his aircraft. The flight suit and all ALSS equipment recovered were cut with a sharp object; they also had blood stains, but none suggesting massive external bleeding (photo 15-16, enclosure 5). No human remains were found in the vicinity of the crash site. The recovery team reported that the cockpit area of the aircraft, including ejection-seat components, was removed prior to the excavation of the site by the ICRC/ROI team excavation. Pending new information, no further excavation is required at the crash location.

Enclosure(s):

1. General location of crash site.
2. Topographic location of project area and relative location of the recovered materials.
3. Sketch map of site.
4. List of photographs.
5. Photographs (16).

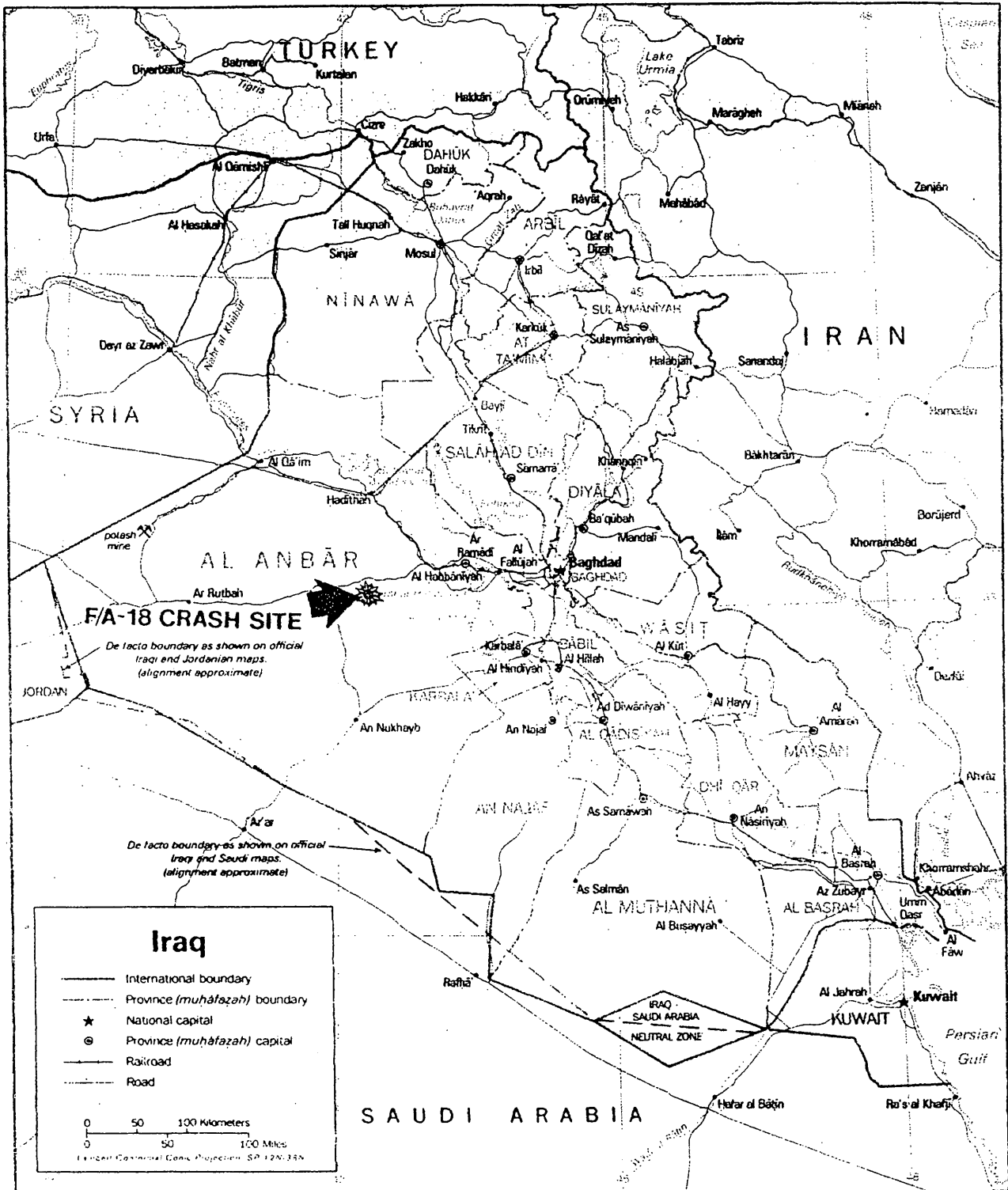

Enclosure 1

General Location of Project Area

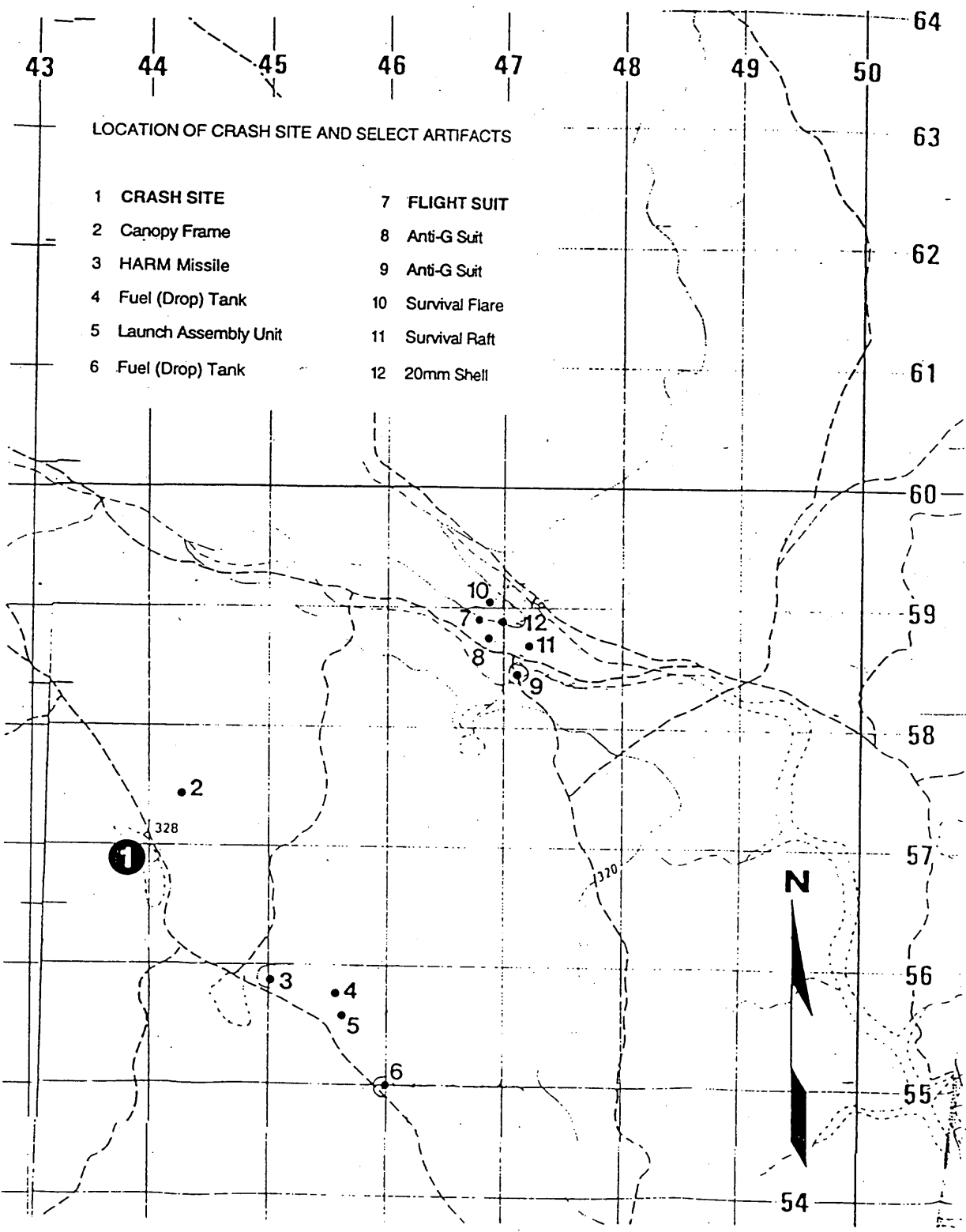
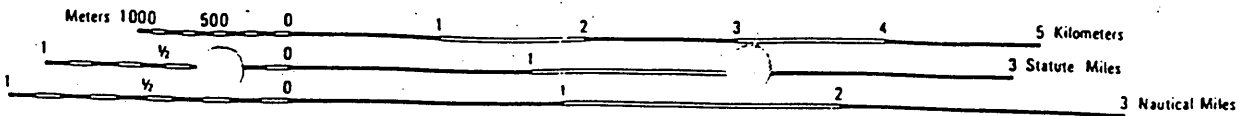

Tulul Ad Dulaym; Edition I-DMA; Series K743; Sheet 4456 II
 Scale 1:50,000; Horizontal Datum: World Geodetic System, 1994

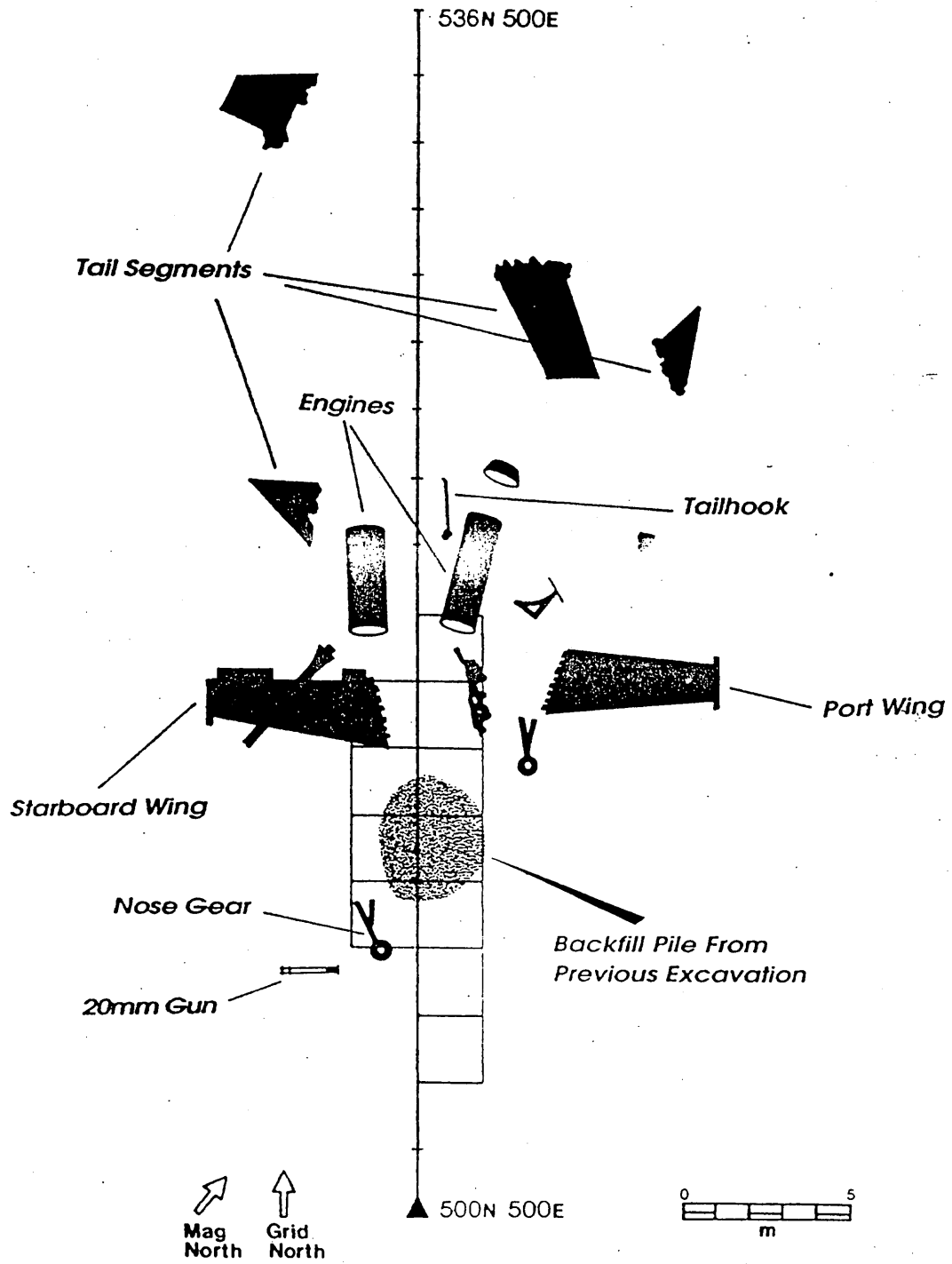

Enclosure 3

Sketch Map of Site

Liotta, Alan, CIV, OSD/DPMO

From: Fred_Smith [Fred_Smith@nts.policy.osd.pentagon.smil.mil]
Sent: Tuesday, December 16, 1997 12:39 PM
To: liotaa
Subject: RE: Meeting with Senators Smith and Grams

Senator Smith just called back. We had a good discussion. He said he went into yesterday's meeting angry, but we did a good job of answering his questions and he was satisfied. He also told me about the Toon/Joint Commission meeting earlier in the day. He thinks they are "doing good work; good leads," etc., etc.. We wished each other a Merry Christmas, and said we would see each other next year!

liotaa@dpmos.policy.osd.pentagon.smil.mil on 12/16/97 11:01:00 AM

To: Fred Smith/ISA/OUUSD
CC:
Subject: RE: Meeting with Senators Smith and Grams

Fred:

CIL sent me a map last nite of where they searched, and the site of the symbol was well within this area. In fact, NIMA says the symbol is about 900 meters (less than a click) away, but the team searched 5 clicks out. I still think you should call Smith and Grams, but insist on talking to the members, not staffers.

By the by, I still disagree with you that our letter was misleading. If you look at the original constituent letter, how that was sent to us by Grams, and the facts surrounding the case (including the classification of the imagery and the analysis), our response was factual and accurate. Could it have been more robust? Possibly, although we then would have been treading dangerously close to disclosing classified information. Should we have called to brief Grams? In hindsight, yes. But given the way the request was received from his office, we had no indication of any particular interest in this case. We'll be more sensitive next time. Alan

From: Fred_Smith
To: Franklin_Kramer
Cc: Alan_Liotta; liotaa
Subject: Meeting with Senators Smith and Grams
Date: Monday, December 15, 1997 5:57PM

Frank, our meeting with Smith and Grams went OK. It started out rather testy, but after responding to several of Smith's questions, he became more relaxed and we had a civil discussion. Grams was concerned about a letter sent to him by Jim Wold earlier this year; Grams claims the letter was misleading. I looked at the letter and agreed. Much of the hour and a

half discussion centered on the report of a man-made symbol in the vicinity of Speicher's crash site and the fact that the Navy has declared Speicher "Killed in Action--Body Not Recovered. On the latter, I assured Smith that the Navy's designation of the case has no bearing on how we prosecute it. It is an active case. I think Smith was reasonably satisfied with the answers he received today. The problem, however, is his staffers. These guys will probably be spurred on by what they heard today and continue to press the issue in some form, possibly a hearing at a later date. At the end of the meeting, I told Senator Smith that you are interested in getting back together (i.e., another breakfast). Smith was pleased to hear that. Footnote: The first and last thing Smith wanted to talk to me about was baseball. He still remembers the fact that you and I are Dodger fans.

16 December 1997

SUBJECT: Map of Investigation Area

DISCUSSION: Map provided by CILHI to define area ground searched during excavation of LCDR M. S. Speicher's crash location. Area within X's was walked for any signs of wreckage, symbols, life support equipment.

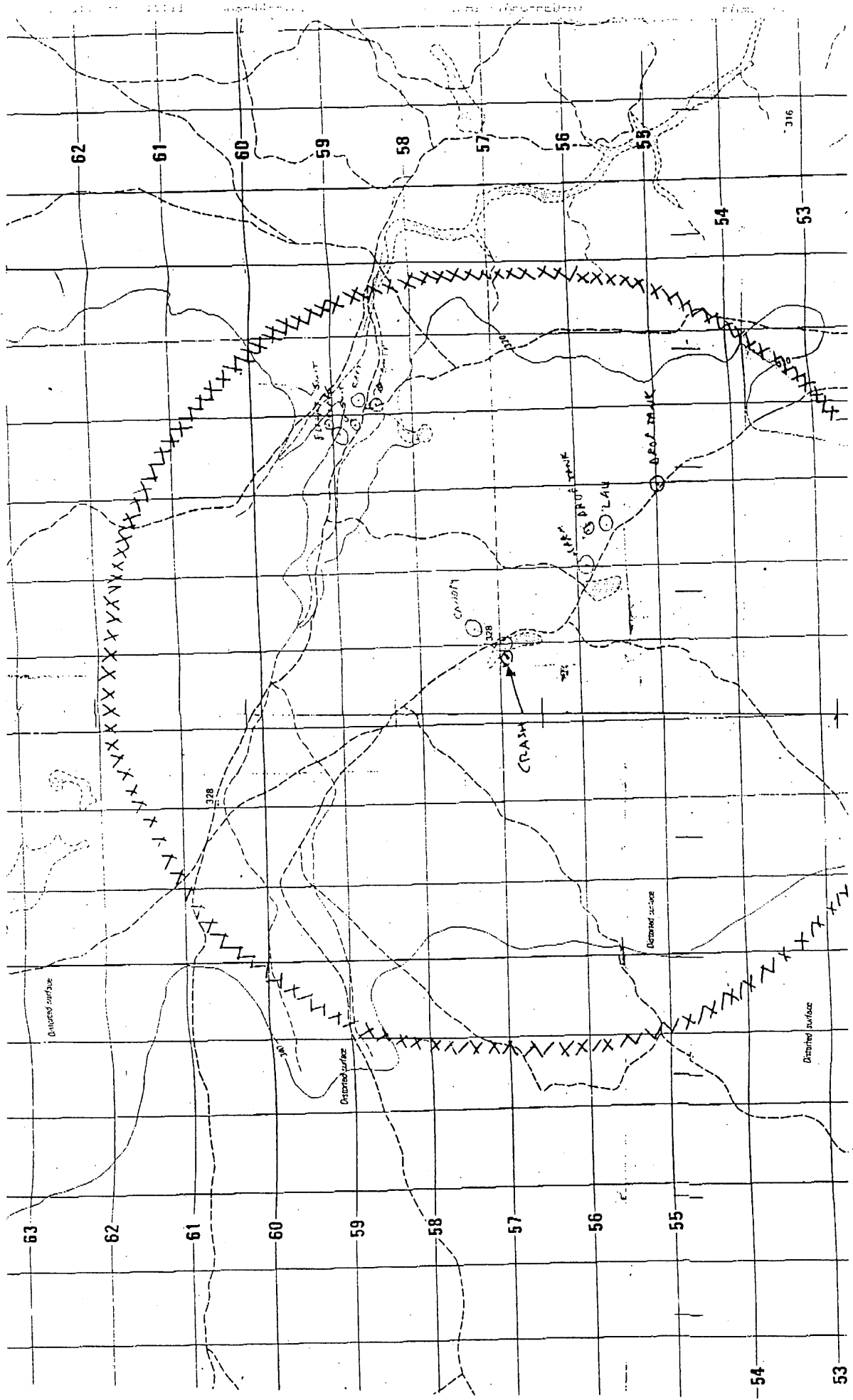

/10/97 WED 12:30 FAX 202 224-1353

SENATOR BOB SMITH

002

BOB SMITH
NEW HAMPSHIRE
1-800-922-2230
IN NEW HAMPSHIRE
opinlon@amith.senate.gov

SELECT COMMITTEE ON
ETHICS
COMMITTEE ON ARMED SERVICES
COMMITTEE ON
ENVIRONMENT AND PUBLIC WORKS

United States Senate
WASHINGTON, DC 20510-2903

December 10, 1997

The Honorable Franklin Kramer
Assistant Secretary of Defense
International Security Affairs
Department of Defense
Washington, D.C. 20301

Dear Frank:

I am extremely concerned about this past Sunday's *New York Times* article about DoD's efforts to account for Lt. Commander Michael Speicher from the Gulf War, especially in view of a briefing I received on this case by Alan Liotta from DFMO on January 17, 1996 where I was told that there were no indications that Commander Speicher might have survived his loss incident.

I would like to meet with you, Fred Smith, and Alan Liotta on Monday, December 15th, to discuss both the intelligence and the policy DoD has pursued regarding this case. I would also request that you bring the documentation referenced in the *New York Times* article, including the document referencing the detection of "a man-made symbol in the area of the ejection seat."

I am hosting a meeting in my office of the U.S. side of the U.S.-Russia Joint Commission on POWs and MIAs at 11:00 a.m. that day. It my hope that you might be available following that meeting. Of course, you are welcome to come to that meeting as well.

My point of contact on this matter is Dino Carluccio who may be reached at (202) 224-3828.

Sincerely yours,

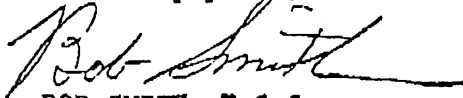
BOB SMITH, U.S.S.

/dlc

cc: The Honorable Sandra K. Stuart
Assistant Secretary of Defense
for Legislative Affairs

DRAKEN BUILDING
SUITE 307
WASHINGTON, DC 20510-2903
(202) 224-2841

1760 ELM STREET
SUITE 100
MANCHESTER, NH 03104
(603) 224-5000

ONE HARBOR PLAZA
SUITE 425
PORTSMOUTH, NH 03801
(603) 433-1607

3 GLEN AVENUE
FIRST FLOOR
BERLIN, NH 03670
(603) 752-2800

Statement by Joanne Speicher Harris

Dated: December 9, 1997

A great deal of publicity has arisen concerning the circumstances of Scott's crash and the subsequent search of the crash area. I have been in constant contact with the United States Navy and the Department of Defense over the years regarding the ongoing investigation. They have kept me informed on all details of the investigation, including certain confidential information.

The family has been subject to intense, invasive media attention, which has been troubling. It is out of a desire to avoid any possible risk of impeding the ongoing, sensitive, investigation, however, that I do not wish to have interviews with the media.



OFFICE OF THE ASSISTANT SECRETARY OF DEFENSE

2400 DEFENSE PENTAGON
WASHINGTON, D.C. 20301-2400



INTERNATIONAL
SECURITY AFFAIRS

25 JUL 1996
In reply refer to:
I-96/42828

Honorable Rod Grams
United States Senator
2013 2nd Avenue North
Anoka, MN 55303

Dear Senator Grams:

Thank you for your recent letter to the Assistant Secretary of Defense for Legislative Affairs on behalf of Mr. Richard Daly. Mr. Daly asked six questions; two concerned Navy Lieutenant Commander Michael Speicher and four concerned alleged pilot distress symbols in Southeast Asia. Since my agency, the Defense POW/MIA Office (DPMO), is the Department of Defense agency responsible for the prisoner of war/missing in action issue, your letter was forwarded to me.

Regarding Mr. Daly's first two questions, Commander Speicher's F/A-18 aircraft was shot down on January 17, 1991, during the Persian Gulf War. He is listed as killed in action/body not recovered (KIA/BNR). The term KIA/BNR reflects an accurate accounting status as determined by the Secretary of the Navy. However, we continue to investigate and pursue every avenue that may possibly lead to repatriation of his remains. His crash site, located west of Baghdad in 1994, was recently investigated. Information found during the investigation is being analyzed and will be released when the investigation is complete and Commander Speicher's family has been fully informed.

Mr. Daly's remaining questions are addressed in detail in the enclosed statement of Duane P. Andrews to the Senate Select Committee in 1992, and in the DoD/POW-MIA paper dated November 1995. Most recently the Department of Defense completed a comprehensive analytic review of all cases of unaccounted for Americans in Southeast Asia which took into consideration all the information available to the United States Government since 1975. As a result, next steps have been identified for some cases, some await new leads, and a third category of cases has been turned over to the respective host governments as cases which require unilateral action on the part of those governments.



The questions concerning imagery and symbols such as Mr. Daly raises have been provided no further leads. To put this in perspective it may be useful to note Mr. Andrews' testimony during which he stated, "of all the millions of square kilometers of territory in Southeast Asia that we have examined over the years, we really have only two unexplained sets of symbols which were clearly intended to communicate something to an observer from above. And that's the 19 or 1573 TH, and the USA with the possible K." As Mr. Andrews also stated, we have always followed up on such information, but without any results or further leads to date.

I hope this information is useful. Should you have any further questions, please contact my office.

Sincerely,

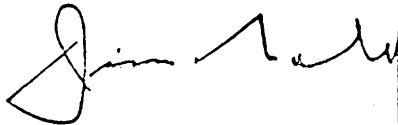

James W. Wold
Deputy Assistant Secretary of Defense
(POW/MIA Affairs)

Enclosures:
As stated

COMMITTEES:

BANKING, HOUSING, AND URBAN AFFAIRS

ENERGY AND NATURAL RESOURCES

FOREIGN RELATIONS

JOINT ECONOMIC

United States Senate

WASHINGTON, DC 20510

1996 JUN 12 PM 1:43

PH. 202-224-3244
FAX 202-228-0956

INTERNET: MAIL_GRAMS@GRAMS.SENATE.GOV

MINNESOTA OFFICE:

2013 SECOND AVENUE NORTH
ANOKA, MN 55303
PH. 612-427-5921
FAX 612-427-8872

June 7, 1996

Assistant Secretary of Defense For Legislative Affairs
Department of Defense
The Pentagon, Room 3E966
Washington, DC 20301

Dear Assistant Secretary:

Recently I was contacted by Rich Daly, Research Director for Minnesota Won't Forget POW/MIA, regarding his concern over contradictory stories relating to pilot distress symbols during and after the Vietnam War. For your review, I have enclosed a copy of the information which has been provided to my office. Mr. Daly has asked me to forward this letter to your office.

I would appreciate receiving any information you may have regarding this situation. Please address any correspondence to the attention of John Revier, of my staff, at 2013 2nd Avenue North, Anoka, Minnesota 55303, phone: 612-427-5921.

Any assistance your office can provide will be greatly appreciated.

Sincerely,

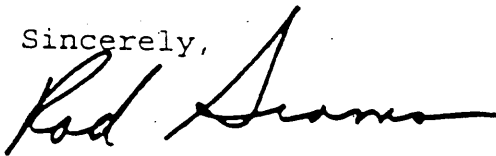

Rod Grams
United States Senator

RG:jr

enclosure



MINNESOTA WON'T FORGET POW/MIA

February 21, 1996

Dear Senator Grams:

As you know, there are contradictory stories relating to pilot distress symbols matching those of Vietnam War pilots, in particular the June 5, 1992, symbols at Dong Vai prison. Recent news releases stated the U.S. government was searching for the remains of Gulf War pilot Michael Speicher at his crash site. The Army Times quoted Pentagon spokeswoman Beverly Baker as saying "Nothing they found would indicate he survived."

There has been information circulating that Michael Speicher's distress symbol was spotted by U.S. satellites. It appears that once again, the public is not receiving the truth.

We believe that the Congress and people deserve the truth. Determining the fate of missing servicemen is supposedly of the highest national priority. I ask that you put the following questions directly to Secretary of Defense Perry:

- 1) Did U.S. satellites pick up pilot distress symbols correlating to Michael Speicher?
- 2) Is there any evidence Speicher did not die in his crash?

3) The symbols "GX2527" were found at Dong Vai prison Vietnam in June 5, 1992 satellite photographs.

Does the Defense Department consider these as valid pilot distress symbols?

4) Did any employee of the Defense Department see the letters "SEREX" in June 5, 1992 photographs of the field next to Dong Vai prison.

5) Were ("G" and "X") and ("T" and "A") ever valid E & E letter pairs during the Vietnam War?

6) Were the 1988 symbols "USA" in satellite photos of Laos dug into the ground or were they created by material piled on top of the ground?

Sincerely,

Richard A. Daly Research Director.

MINNESOTA WON'T FORGET POW/MIA

Valley Ridge Shopping Center 2107½ W. Burnsville Parkway Burnsville, MN 55337
(612) 894-1776 FAX (612) 890-0017

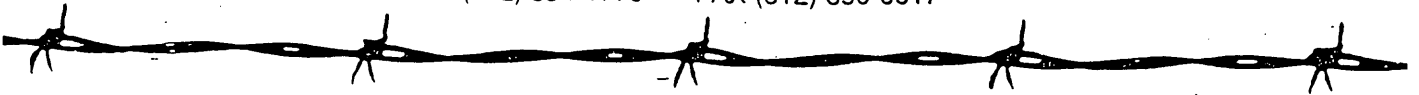



INTERNATIONAL
SECURITY AFFAIRS

OFFICE OF THE ASSISTANT SECRETARY OF DEFENSE

2400 DEFENSE PENTAGON
WASHINGTON, D.C. 20301-2400



22 JUL 1996

In reply refer to:
I-96/18918

Honorable Herb Kohl
United States Senate
Washington, DC 20510-4903

Dear Senator Kohl:

Thank you for your recent letter to the Secretary of State on behalf of Mr. Steven Meudt. Mr. Meudt is seeking information regarding the status of POW/MIAs and the status of Navy Lieutenant Commander Michael S. Speicher.

The Department of Defense has committed several hundred personnel to achieve the fullest possible accounting for Americans, both military and civilian, who have been lost due to hostile action. To date, despite intensive intelligence collection and in-country operational efforts, no evidence has been found indicating any American servicemen have been held against their will in Southeast Asia after Operation Homecoming in 1973. After Operation Homecoming, numerous American civilians were detained by the communist regime, especially during the fall of Saigon in April 1975. These people were either subsequently released, or in the cases of those who died while being detained, had their remains returned. Nevertheless, every POW/MIA report received by the United States Government, whether purporting a live sighting, an aircraft crash, the grave-site of an American, or identification information, is taken seriously and investigated.

The United States Government continues to aggressively pursue POW/MIA issues with the governments of Vietnam, Laos, Cambodia, China, and Russia on the 2,150 individuals who remain missing or unaccounted for from the war in Southeast Asia. As our diplomatic relations with these governments have improved, so has our access to archival information and on-site investigations relative to unaccounted for Americans. Since 1973, 433 sets of remains returned to the United States from Southeast Asia have been identified and returned to their families with full military honors.



Commander Speicher's F/A-18 aircraft was shot down on January 17, 1991, during the Persian Gulf War. He is listed as killed in action/body not recovered (KIA/BNR). The term KIA/BNR reflects an accurate accounting status as determined by the Secretary of the Navy. However, we continue to investigate and pursue every avenue that may possibly lead to repatriation of his remains. His crash site, located west of Baghdad in 1994, was recently investigated. Information found during the investigation is being analyzed and will be released to the public once the investigation is complete and Commander Speicher's family has been fully informed.

I hope you find this information useful. Should you have any further questions, please contact my office.

Sincerely,

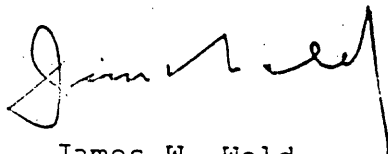

James W. Wold
Deputy Assistant Secretary of Defense
(POW/MIA Affairs)

cc:
Navy casualty

HERBERT KOHL
WISCONSIN

WASHINGTON OFFICE:
330 HART SENATE OFFICE BUILDING
WASHINGTON, DC 20510
(202) 224-5653
T.O.D. (202) 224-4484

United States Senate

WASHINGTON, DC 20510-4903

COMMITTEES:
APPROPRIATIONS
JUDICIARY
SPECIAL COMMITTEE
ON AGING

February 29, 1996

*Commander Mark Jensen
(703) 602-2102
x158*

The Honorable Warren Christopher
Secretary of State
U.S. Department of State
2201 C Street N.W.
Washington, D.C. 20520-0000

Dear Secretary:

Enclosed please find a copy of a correspondence from a constituent of mine, Steven Meudt, regarding the status of American POWs and MIA.

Any assistance you could provide in responding to these concerns would be greatly appreciated. Please respond directly to my constituent and send a copy to the attention of Daniel Smyczek of my staff.

Thank you for your attention to this matter.

Sincerely,
Herb Kohl
Herb Kohl
U.S. Senator

HK:ds
Enclosure

9600-1404

MILWAUKEE OFFICE:
310 WEST WISCONSIN AVENUE
SUITE 950
MILWAUKEE, WI 53203
(414) 297-4451

MADISON OFFICE:
14 WEST MIFFLIN STREET
SUITE 312
MADISON, WI 53703
(608) 264-5138

EAU CLAIRE OFFICE:
402 GRAHAM AVENUE
SUITE 206
EAU CLAIRE, WI 54701
(715) 832-8422

APPLETON OFFICE:
4321 WEST COLLEGE AVENUE
SUITE 235
APPLETON, WI 54914
(414) 738-1640

1996 FEB 23 AM 9:45

2/18/96

Senator Herb Kohl
% U.S. Senate Office Bldg
Washington, D.C. 20510

Dear Senator Kohl,

I hope you are in good health and spirits. There are a couple of concerns I would like you to investigate. First I would like you to know that I am a supporter of the Asia Vietnam Vets Chapter IV. Recently I was reading a publication reporting on the whereabouts of a Lt. Cmdr Michael S. Spindler whom was shot down Jan 16 1991 in the Gulf War. Please find out why our Government can't locate him. Also of concern is the status of our P.O.W & M.I.A's? What is happening --- it appears that we are more concerned about other ~~people in other countries than we are about the boys~~ whom serve this country!! How can I endorse serving this Country's Military to my Children when it abandons its soldiers?

One other concern of mine deals with the Old Car Club. I recently read an article in "Old Cars Weekly" dated 1/96 (which is enclosed) dealing with a proposal by a Mark Morris to ban "Jaguar Things" which is important to the restoration of Old Cars. It is not my wish to

have this product banned. I have written to Mr. Morris
of my concerns. I am asking you Mr. Hill to look into
these concerns of mine and please let me know of your
findings.

Sincerely Yours

Stuart Marks



Previously redacted/declassified
by another agency



DEFENSE PRISONER OF WAR/MISSING IN ACTION OFFICE
2400 DEFENSE PENTAGON
WASHINGTON, DC 20301-2400



27 JUN 1995
In reply refer to:
196/21076

Bureau Of Naval Personnel
Attn: Pers-06L
2 Navy Annex
Washington, D.C. 20370

The Defense POW/MIA Office is the lead office for central coordination within the Department of Defense for the case of Lieutenant Commander Speicher who became missing in action during Operation Desert Storm and remains unaccounted for.

All requests for information and inquiries regarding the case of Lieutenant Commander Speicher, including FOIA requests and Congressional inquiries, will be forwarded to this office for response and action. Copies of responses will be provided to your office when completed.

The point of contact within the Defense POW/MIA Office is Mr. J. Alan Liotta, (703) 602-2102, ext.150.

J. Alan Liotta
Deputy Director

Connie —

Please make sure nothing leaves BUPERS on this case w/o DCAP check or signature.





INTERNATIONAL
SECURITY AFFAIRS

OFFICE OF THE ASSISTANT SECRETARY OF DEFENSE

2400 DEFENSE PENTAGON
WASHINGTON, D.C. 20301-2400



16 JUL 1996

In reply refer to:
I-96/18839

Honorable Sonny Bono
House of Representatives
Washington, DC 20515

Dear Congressman Bono:

Thank you for your recent inquiry on behalf of Ms. Jeanne Joyce. Ms. Joyce was interested in United States efforts to find the remains of United States Navy Lieutenant Commander Michael Speicher, who was shot down during the Persian Gulf War, and is listed as killed in action/body not recovered (KIA/BNR).

The term KIA/BNR reflects an accurate accounting status as determined by the individual Service Secretaries. However, in our unwavering commitment to bring home or account for each and every American lost due to hostile action, we continue to investigate and pursue every avenue toward possible repatriation of remains. As we gain access to crash sites and/or credible information develops in each case, we actively pursue the recovery of remains. Such is the case of Lieutenant Commander Michael Speicher, whose loss incident is currently under investigation.

In December 1995 the Department of Defense dispatched investigators from the United States Army Central Identification Laboratory, Hawaii, and the United States Navy to Jordan to form the nucleus of a team lead by the International Committee of the Red Cross. The team entered Iraq, with the permission of the Iraqi Government, located the crash site West of Baghdad, and conducted a thorough investigation. Information found during the investigation is currently being analyzed. There is no evidence indicating Commander Speicher is being held in Iran.

The United States Government is committed to the fullest possible accounting for every service man and woman who did not return home from America's conflicts. I hope you find this



information useful. Should you have any further questions,
please contact my office. I appreciate your interest in this
issue.

Sincerely,

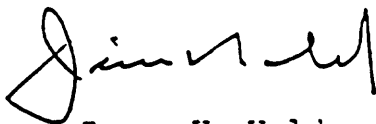
A handwritten signature in black ink, appearing to read "James W. Wold". The signature is fluid and cursive, with a large initial "J" and a stylized "W".

James W. Wold
Deputy Assistant Secretary of Defense
(POW/MIA Affairs)

cc:
Navy casualty



DEFENSE PRISONER OF WAR/MISSING PERSONNEL OFFICE
2400 DEFENSE PENTAGON
WASHINGTON, DC 20301-2400

12 FEB 1998

In reply refer to:
I-98/61314

Mr. Charles Hoskinson
~~_____~~
~~_____~~

(b)(6)

Dear Mr. Hoskinson:

Thank you for your recent telephone call to Senator Mack seeking information on Navy Lieutenant Commander Michael Scott Speicher who was killed in action during the Persian Gulf War but whose remains have not been recovered. Senator Mack forwarded your request to our office since we are the Department of Defense (DoD) agency responsible for this issue, and asked that we respond directly to you.

Commander Speicher was lost on January 17, 1991, when his F/A-18 aircraft was downed in Iraq during Operation Desert Storm. The Secretary of the Navy, based on the information known to him at the time of Commander Speicher's loss, assigned his casualty status as KIA-BNR. The Department of the Navy continues to carry Commander Speicher in this status because it reflects the most accurate information to date regarding his fate. However, given our Government's unwavering commitment to obtain the fullest possible accounting for Americans lost due to hostile action, the case was never officially closed. The discovery of intelligence information several years after the loss incident provided our first new clues and allowed us to begin an investigation. Since 1993, we have used all appropriate analytical, diplomatic, intelligence, and scientific means available to mount a comprehensive investigation.

In December 1995, working through the International Committee of the Red Cross, Defense investigators from the Navy and the Army Central Identification Laboratory in Hawaii (CILHI) entered Iraq, with the permission of the Iraqi Government, and conducted a thorough investigation of Commander Speicher's previously unlocated crash site. Although we did not recover Commander Speicher's remains at the crash site, information and aircraft wreckage were recovered which has allowed us to continue our investigation.

Commander Speicher's family has been kept fully informed of the DoD efforts and the information we have obtained. The family has publicly expressed their satisfaction with our actions and also requested information not be released to the public in order to protect their privacy and the integrity of any potential new lead. In addition, as our investigation developed, our office kept the appropriate congressional oversight committees apprised.



Mr. Hoskinson, the men and women of this office gratefully appreciate your concern for Commander Speicher. If you wish to learn more about our agency and our operations throughout the world, I recommend you contact our Internet site at www.dtic.mil/dpmo. I hope this information is helpful.

Sincerely,

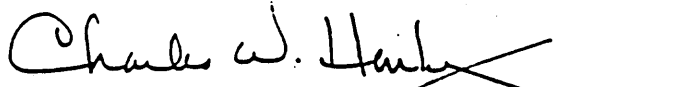

Charles W. Henley
Legislative and External Affairs
Defense POW/Missing Personnel Office

cc:

Senator Mack's office (Ms. Otis)

Navy casualty office *



DEFENSE PRISONER OF WAR/MISSING PERSONNEL OFFICE
2400 DEFENSE PENTAGON
WASHINGTON, DC 20301-2400

10 APR 1998

In reply refer to:
I-98/65020

Honorable Orrin G. Hatch
United States Senator
Washington, DC 20510-4402

Dear Senator Hatch:

Thank you for your March 23, 1998, letter to Assistant Secretary of Defense Sandra Stuart on behalf of Mr. Robert Weaver, Jr. Mr. Weaver seeks information about Navy Lieutenant Commander Michael Scott Speicher who was killed in action during the Persian Gulf War but whose remains have not been recovered. Mr. Weaver also enclosed a letter to Secretary of Defense Cohen on this subject and states that he never received a reply. Your letter was forwarded to our office since we are the Department of Defense (DoD) agency responsible for this issue, and we are pleased to provide you the following information for your use in responding to Mr. Weaver.

We checked our correspondence files, as well as those of the Office of the Secretary of Defense (OSD) regarding Mr. Weaver's December 7, 1997, letter to Secretary Cohen. We could find no record that Mr. Weaver's letter was ever received by OSD.

Commander Speicher was lost on January 17, 1991, when his F/A-18 aircraft was downed in Iraq during the Persian Gulf War. The Secretary of the Navy, based on the information known to him at the time of Commander Speicher's loss, assigned his casualty status as killed in action-body not recovered. The Department of the Navy continues to carry Commander Speicher in this status because it reflects the most accurate information to date regarding his fate. However, given our Government's unwavering commitment to obtain the fullest possible accounting for Americans lost due to hostile action, the case was never officially closed. The discovery of his crash site several years after the loss incident provided our first new clues and allowed us to begin an investigation. Since 1993, we have used all appropriate analytical, diplomatic, intelligence, and scientific means available to mount a comprehensive investigation.

In December 1995, working through the International Committee of the Red Cross, Defense investigators from the Navy and the Army Central Identification Laboratory in Hawaii (CILHI) entered Iraq, with the permission of the Iraqi Government, and conducted a thorough investigation of Commander Speicher's crash site. Although we did not recover Commander Speicher's remains at the crash site, information and aircraft wreckage were recovered which has allowed us to continue our investigation.



Commander Speicher's family has been kept fully informed of DoD efforts and the information we have obtained. The family has expressed publicly their satisfaction with our actions and has requested information not be released to the public in order to protect their privacy and the integrity of any potential new lead. In addition, as our investigation has developed, our office has kept the appropriate congressional oversight committees apprised.

Senator Hatch, your continued concern and support for this important issue are gratefully acknowledged and appreciated by the men and women of this office. So that Mr. Weaver may stay abreast of our current operations throughout the world, I recommend you have him contact our Internet site at www.dtic.mil/dpmo. If you or your staff have further questions regarding this issue, please do not hesitate to contact our office.

Sincerely,

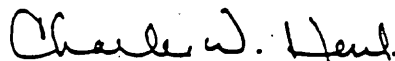

Charles W. Henley
Special Assistant for Legislative Affairs
Defense POW/Missing Personnel Office

cc:
Navy casualty office



17 SEP 1996

In reply refer to:
I-96/18890

MEMORANDUM FOR THE OFFICE OF THE ASSISTANT TO THE SECRETARY
OF DEFENSE FOR PUBLIC AFFAIRS/DFOISR
(ATTN: MAJ CAMPBELL)

SUBJECT: FOIA Requests Regarding LCDR Michael Speicher, USN

References: (a) FOIA Request 95-F-2605 (attached)
(b) FOIA Request 96-F-0368 (attached)
(c) FOIA Request 96-F-1585 (attached)

References are Freedom of Information Act (FOIA) requests for documents related to the loss incident and recent investigation of the crash site of United States Navy Lieutenant Commander Michael Speicher who is listed as Killed in Action/Body Not Recovered as a result of hostilities during the war in the Persian Gulf area. In December 1995, Commander Speicher's crash site was searched by American investigators. The investigation of his case, based upon evidence collected during this activity and other available information, remains ongoing.

The referenced FOIA cases have been kept open through verbal agreement with your office on the basis of our opinion that the investigation would be finalized in a reasonable time frame. Since it appears that the investigations into Speicher's loss will continue; and since DPMO cannot control the duration of the investigations, DPMO does not believe it advisable to continue to keep these cases in an open status. Further, the investigatory body has advised DPMO that the release of any of the material in the control or possession of DPMO could prejudice the integrity of the investigation.

Recommendation at the level of the Office of the Secretary of Defense, conveyed to Mr. Alan Liotta, Deputy Director, DPMO, is that all documents related to this case be denied in toto as classified under provisions of 5 USC, 552, exemption (b)(1) and Section 1.5 (c) and (d) of E.O. 12958. No documents concerning Commander Speicher will be released until a final determination is made into the investigation of his case. DPMO will remain the office of primary responsibility for future FOIA requests regarding Commander Speicher.

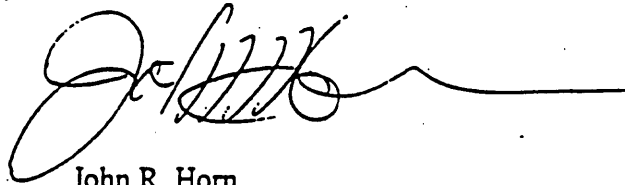

Points of contact for further inquiry into the status of this investigation are Mr. Alan Liotta, Deputy Director, DPMO, and Lieutenant Michael Theres, USN, Navy Casualty Office, Bureau of Naval Personnel (Pers-62CC).

A handwritten signature in black ink, appearing to read 'John R. Horn', with a long horizontal flourish extending to the right.

John R. Horn
Chief, FOIA
Defense POW/MIA Office

Attachments:

As stated

cc:

Navy Casualty Office (LT Theres)
JSSA FOIA (Ms. McDonald)

Ref: 95-F-2605

19 FEB 1996

MEMORANDUM FOR JOINT TASK FORCE- FULL ACCOUNTING
BOX 64044
CAMP H. M. SMITH, HI 96861-4044

SUBJECT: Freedom of Information Act (FOIA) Request -
Lynn Keller (American Journal)

As recommended by the Defense Prisoner of War/Missing in Action Office (DPMO), Office of the Deputy Assistant Secretary of Defense (POW/MIA Affairs), the attached FOIA request is being forwarded as a matter possibly under your cognizance and direct response to the requester. The request was received in this Directorate on December 19, 1995. The requester has been informed of this referral. The action officer in this Directorate is Lieutenant Colonel Pratt at DSN 227-4026 or commercial (703) 697-4026.

SIGNED

A. H. Passarella
Director
Freedom of Information
and Security Review

Attachments:
As stated

Prepared by PRATT:52605M/T:2/14/96:DFOI:X74026:gr ✓pk_y1_ wh_

Ref: 95-F-2605

16 FEB 1996

Ms. Lynn Keller
American Journal
402 East 76th Street
New York, NY 10021

Dear Ms. Keller:

This responds to your December 19, 1995, Freedom of Information Act request, which was processed by the Defense Prisoner of War/Missing in Action Office (DPMO), Office of the Deputy Assistant Secretary of Defense (POW/MIA Affairs).

DPMO advised that it is involved in the ongoing investigation pertaining to Lieutenant Commander Michael Speicher, of which the Office of the Joint Task Force-Full Accounting (JTF-EA), has lead. However, DPMO further advised that it has no records pertaining to Lieutenant Commander Speicher. In an effort to assist you in your search, we have forwarded your request to the JTF-EA for processing and direct response to you. Also, DPMO has provided a copy of a press release related to this investigation which may be of assistance to you.

Should you elect to consider this no record response to be an adverse determination, you may appeal by offering information to support an additional search effort. Any such appeal must be received in this Directorate within 60 calendar days of this letter's date.

There are no assessable fees for this response.

Sincerely,

SIGNED

A. H. Passarella
Director
Freedom of Information
and Security Review

Enclosure:
As stated

Prepared by PRATT:52605L/NR:2/14/96:DFOI:X74026:gr/_pk_y1_wh_

AMERICAN JOURNAL

February 26, 1996

A.H. Passarella
Director
Freedom of Information and Security Review
POW/MIA
DPMO (all requests go thru central Pentagon)
Room 2C 757 Pentagon
Washington, D.C. 20301-1400

Dear Mr. Passarella:

I received your response to my FOIA Ref:95-F-2605. Before I appeal, I wanted to ask you a question. I called your office on Friday and spoke to Jan your secretary, but since I haven't heard back from you, I thought I would fax you this note.

In your letter you say "DPMO advised that it is involved in the ongoing investigation pertaining to Lieutenant Commander Michael Speicher, of which the Office of the Joint Task Force-Full Accounting (JTF-FA), has lead. However, DPMO further advised that it has no records pertaining to Lieutenant Commander Speicher."

I am not clear on one thing. If the DPMO is involved in the Speicher investigation, then how is it possible that it has no records? If you can advise me by close of business today, perhaps I will not have to file an appeal.

Thank you for your assistance.

Sincerely,

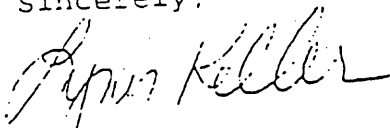

Lynn Keller
Producer
212-439-7197
212-737-4983 (fax)

AMERICAN JOURNAL

Speicher

December 19, 1995

POW/MIA
DPMO
Director
Freedom of Information and Security Review
Room 2C 757 Pentagon
Washington, D.C. 20301-1400
Att'n: Lt. Col Pratt

Fax: 703-693-7341

Dear Lt. Col Pratt:

Under the provisions of the Freedom of Information Act (5 U.S.C. 552), I am writing to request all records relating to Lt. Cmdr. Michael Scott Speicher, specifically live sighting reports, evidence of his escape and evasion code on the ground, any records pertaining to his projecting from the aircraft, his survival and capture.

Please inform me should there be any fees incurred for searching or copying the records and/or evidence I have requested. However, as a news media representative I believe this request falls within the "pro bono publica" aspect of the Act and therefore, ask that such fees as pertain be waived.

Should you deny all or any part of this request, please cite specific exemptions and inform me of the procedures available regarding administrative appeal process. I appreciate your assistance with my request.

Sincerely,



Lynn Keller
Producer
AMERICAN JOURNAL
Ph: (212) 439-7197
Fax: (212) 737-4983

AMERICAN
JOURNAL

21 FEB 1996

94-F-0368

FOIA Officer
Joint Chiefs of Staff

Dear Sir or Madam:

Under the provisions of the Freedom of Information Act (5 U.S.C. 552), I request all records--including photos--relating to briefings given to the JCS Chairman from 1 JAN 1995 to 1 NOV 1995 concerning the searches for, loss of and/or status of Lt. Cmdr. Michael Scott Speicher, USN, (dob of app. 1958), missing in action over Iraq on or about 16 JAN 1991. Speicher has been declared dead by the DOD (see attached) and therefore files pertaining to him are releasable.

While I am not providing a social security number for Speicher, he is the only person of this name to be MIA/KIA in Desert Storm. Therefore this request includes enough data for you to make a reasonable search of your finding aids and records.

I am prepared to pay reasonable fees for this request, but request you waive them as I am a member of the media and will use these records for journalism of benefit to the public.

Thank you for your kind assistance.

Sincerely,

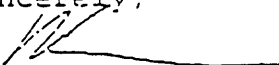
Mark Sauter
Correspondent
(212) 439-7181



DEPARTMENT OF THE AIR FORCE

11TH WING

August 8, 1996

MEMORANDUM FOR OASD(PA)DFOISR

FROM: OL-P, 11 CS/SCSR (FOIA)
1000 Air Force Pentagon
Washington DC 20330-1000

SUBJECT: Freedom of Information Act Request -- Case #96-1054

1. In accordance with Title 5, United States Code, Section 552, we are forwarding the attached request for action with direct reply to the requester.
2. The requester has been notified of this referral.
3. Please direct all questions to the undersigned at DSN 225-4992.

A handwritten signature in cursive script, reading "Patricia D. Grace", is positioned above the printed name.

LATRICIA D. GRACE
Freedom of Information Manager

Attachments:

1. FOIA Request
2. Background Material



DEPARTMENT OF THE AIR FORCE
HEADQUARTERS UNITED STATES AIR FORCE
WASHINGTON DC

5 Aug 96

MEMORANDUM FOR OL-P, 11CS/SCSR

FROM: XOS

SUBJECT: FOIA Case 96-1054

We have reviewed subject FOIA and forward JSSA's memo. Please note that information requested is not maintained by our agency. Please forward the case to agencies specified in the JSSA memo to possibly obtain the documents requested. If you have any questions, please contact Ms. Romero at 614-8874.

M. ROMERO, DAFC, USAF
XO FOIA Monitor
DCS, Plans and Operations

Atch
JSSA w/FOIA Case 96-1054



JOINT SERVICES SURVIVAL, EVASION,
RESISTANCE AND ESCAPE (SERE) AGENCY
FT BELVOIR, VIRGINIA 22060-5212

26 July 1996

MEMORANDUM FOR AF/XOS

Attn: Mardy Romero

FROM: HQ JSSA/TN
9018 Black Road, Suite 101
Ft Belvoir, VA 22060-5212

SUBJECT: Freedom of Information Act Request Case 96-1054

1. All files pertaining to Lt Cmdr Michael Speicher fall under the purview of DPMO. Yesterday I spoke with Mr. John Horn, FOIA POC at DPMO, and we both agreed that this case should be sent to them for action.
2. If you have not already done so, I also suggest you contact JSOC and J3SOD. It is possible that they might also have files pertaining to Cmdr Speicher.
3. If you have any questions, please contact me at 703-806-6419/6420.

DEBRA A. MACDONALD, GS-13, DAF
Chief, Library/Archives Branch



DEPARTMENT OF THE AIR FORCE
AIR FORCE OFFICE OF SPECIAL INVESTIGATIONS

96-1054

MEMORANDUM FOR 11 MSS/MSIS (FOIA)
ATTENTION: Ms. Grace

JUN 18 1996

FROM: AFOSI IOC/DIR
500 Duncan Avenue, Room 1009
Bolling AFB DC 20332-6000

SUBJECT: Freedom of Information Act (FOIA) - Trent Gillies
ACTION MEMORANDUM

1. On 29 March 1996 we received a request for information from Mr. Trent Gillies, Producer of American Journal. Mr. Gillies is requesting information regarding Lt Cmdr Michael Speicher who was missing in action over Iraq on or about 16 January 1991.
2. We determined that your agency may be maintaining information responsive to this request.
3. We are forwarding the request to you for review and direct response to the requester.
4. The requester has been advised of this referral.

FRANK H. BATTEN JR., SA
Chief, Information Release

- 2 Attachments:
1. Cy of Request
 2. AFOSI Response



Investigative Operations Center (IOC)/DIR
500 Duncan Avenue, Room 1009
Bolling AFB DC 20332-6000

JUN 18 1996

American Journal
Trent Gillies, Producer
402 East 76th Street
New York, NY 10021

Dear Mr. Gillies

Reference our letter of 29 March 1996 regarding your request for information, concerning Lt Cmdr Michael Spiecher.

We have conducted a search of our files and we have determined that the Air Force Office of Special Investigations is not maintaining any information responsive to your request.

If you interpret this "no records" response as a adverse action, you may appeal it to the secretary of the Air Force within 60 days from the date of this letter. Include in the appeal your reasons for reconsideration, and attach a copy of this letter. Address your letter as follows:

Secretary of the Air Force
Thru: Investigative Operations Center (IOC)/DIR
500 Duncan Avenue, Room 1009
Bolling AFB DC 20332-6000

However, your request has been referred to the office listed below for further action and direct response to you.

11 MSS/MSIS (FOIA)
1000 Air Force Pentagon
RM 4A1088C
Washington, DC 20330-1000

Sincerely

FRANK H. BATTIEN JR., SA
Chief, Information Release



DEPARTMENT OF THE AIR FORCE

11TH WING

August 8, 1996

OL-P, 11 CS/SCSR (FOIA)
1000 Air Force Pentagon
Washington DC 20330-1000

Mr Trent Gillies, Producer
402 East 76th St
New York NY 10021

Dear Mr. Gillies

We are responding to your March 29, 1996, Freedom of Information Act request.

The information you requested is not maintained by our agency. Therefore, we have transferred your request to:

Directorate, Freedom of
Information & Security Review
OASD(PA)DFOISR
Room 2C757, Pentagon
Washington, DC 20301-1400

They will reply directly to you.

If you have any questions concerning this transfer, please direct them to the undersigned at (703) 695-4992.

Sincerely

A handwritten signature in cursive script, appearing to read "Patricia D. Grace".

LATRICIA D. GRACE
Freedom of Information Manager

#96-1054

27 MAR 1996

FOIA Officer
AFOSI
(301) 870-1116

Dear Sir or Madam:

Under the provisions of the Freedom of Information Act (5 U.S.C. 552), I request all records--including photos--relating to the loss and subsequent searches for and/or status of Lt. Cmdr. Michael Scott Speicher, USN; (dob of app. 1958), missing in action over Iraq on or about 16 JAN 1991 (see attached). Speicher has been declared dead by the DOD and therefore his files are releasable.

While I am not providing a social security number for Speicher, he is the only person of this name to be MIA/KIA in Desert Storm. Therefore this request includes enough data for you to make a reasonable search of your finding aids and records.

I am prepared to pay reasonable fees for this request, but request you waive them as I am a member of the media and will use these records for journalism of benefit to the public.

Thank you for your kind assistance.

Sincerely,

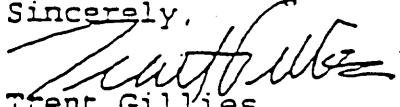

Trent Gillies
Producer
AMERICAN JOURNAL
(212) 439-7315

96-1054

3 MAR 96 8:43

MAR 96 8:43



2400 DEFENSE PENTAGON
WASHINGTON, DC 20301-2400



18 OCT 1996

In reply refer to:
I-96/19324

Honorable John McCain
United States Senate
Washington DC 20510-0303

Dear Senator McCain:

Thank you for your recent letter regarding an offer by Mr. Dave Norris, a private citizen, to travel to the Middle East to search for and recover the remains of a United States Navy pilot.

Lieutenant Commander Michael S. Speicher's F/A-18 aircraft was shot down on January 17, 1991, during the Persian Gulf War. He is listed as killed in action/body not recovered (KIA/BNR). KIA/BNR reflects an accurate accounting status as determined by the Secretary of the Navy. However, in our commitment to bring home or account for each and every American lost due to hostile action, we continue to investigate and pursue every avenue toward possible repatriation of his remains. His crash site was located west of Baghdad in 1994.

In December 1995, the Department of Defense (DoD) dispatched investigators from the United States Army Central- Identification Laboratory in Hawaii and the United States Navy to Jordan to form the nucleus of a team lead by the International Committee of the Red Cross. The team entered Iraq, with the permission of the Iraqi Government, located the crash site, and conducted a thorough investigation. Information found during the investigation is being analyzed and will be released once the investigation is complete and the family has been informed.

DoD receives offers on a regular basis from concerned citizens like Mr. Norris who wish to assist the Government in its effort to provide an accounting of servicemen. While we are genuinely thankful for such offers to assist in this humanitarian issue, Department of Defense policy is to decline all offers for volunteer services from private citizens to perform duties assigned to United States active duty military personnel and civil service employees. Duties associated with site surveys, investigations, and excavations incur substantial risks. Our Government is unable to assume responsibility for the safety and well-being of private citizens.



Mr. Norris' interest in assisting in any capacity is commendable; however, for the reasons cited we cannot sanction a private search. Please thank Mr. Norris for his interest in Department of Defense efforts to achieve the fullest possible accounting for our missing servicemen. Your continued interest and support in this issue are appreciated.

Sincerely,

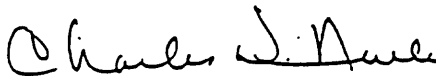

Charles W. Herley
Special Assistant
for Legislative Affairs
Defense POW/MIA Office

cc:
Navy casualty
CILHI

United States Senate

May 30, 1996

1830 SOUTH ALMA SCHOOL ROAD
SUITE 378
MESA, AZ 85210
(602) 491-4300

7400 EAST ARIZONA
BRYANT CIRCLE
SUITE 1180
PHOENIX, AZ 85018
(602) 962-2410

480 WEST PASEO REGIONAL
SUITE 200
TUCSON, AZ 85701
(520) 870 6334

TELEPHONE FOR HEARING IMPAIRED
(202) 224-7132
(602) 952-0170

Captain Billy Lewis
Director, Senate Liaison
Department of the Navy
SR 182
Washington, D.C. 20510-0001

Dear Captain Lewis:

I have enclosed an inquiry which I have received from Dave Norris of Santa Monica, California.

I would greatly appreciate it if you would review this material within existing rules, regulations and ethical guidelines. Please provide me with a prompt response addressing this issue.

PLEASE MARK THE ENVELOPE TO THE ATTENTION OF: Sarah Lowery in my Washington office, 241 Russell Senate Office Building, Washington, D.C. 20510. Thank you very much for your kind assistance and cooperation.

Sincerely,

John McCain
John McCain
United States Senator

JUL 11 1996

received from Mr. LOTT -

Please put into Formal
Tasking system - pp
summary (NO COPIES)

OPTIONAL FORM 99 (7-90)

FAX TRANSMITTAL

of pages = 5

To <i>Ray Lotta</i>	From <i>Pat Sullivan</i>
Dept./Agency <i>010</i>	Phone # <i>697-5641</i>
Fax # <i>602-1890</i>	Fax # <i>697-8408</i>
<small>NSN 7540-01-317-7366 5099 101 GENERAL SERVICES ADMINISTRATION</small>	

JUL 13 1996

(b)(6)

5/22/96

The Honorable John McCain
United States Senate
241 Russell
Senate Office Building
Washington, D.C. 20501

Dear Senator McCain:

We are old if brief acquaintances. I'm writting you again, to ask your help in a project involving the Iraqis. I requested your assistance last fall forcing the Passport Controll Office to authorize my going to Iraq to conduct an interview with Deputy Prime Minister Tariq Aziz. Unfortunately, I never heard from you and since I am (or was) a member of The Republican Senatorial Inner Circle, a supporter of Senator Gramm (my self having won the Heston Shoots at the Champion level 4 times in the late 80s) and being Rocks sole participant in the All Star Salute To President Reagan---- I was both surprised and a bit hurt at the lack of assistance. Personally, I mark it up to staffers in your office.

As you may be aware, I went on to Iraq and was there as our men left on December 20, 1995 and continued to make nice--again, in case any of our people came into Iraqi hands, I could assist in getting them out and in an attempt to recover Michael Speicher's remains--our Naval Avaitor lost early in the war.

Now I need your assistance again and this time (Attention Staffers) I'll submit my request by Registered Mail and have some one there also ask you personally and be certain you see my request.

In short: I have another invitation from Iraq to visit and wish to succeed in recovering Speicher's remains. Iraq states I may bring a delegation to search as long as I am head of it and they at this point are not picky about whom I bring--obviously members of our Military. What they stated I would need was satalite photos of where to look as according to Dr. Hassan, Iraq's Minister Plenipotentiary, they have no idea where to search.

My Motivation: Why do I wish to do this? For the same reason I was sent to Vietnam in 1972, to recover our lost men. In this case a presumed dead Airman. In 72, it was known there was intrigue afoot in the attempts to recover you guys. A leak was obvious, but where? Thus

I volunteered to go into Vietnam assigned to supply and through association with our folks at Strategic Technical Directorate Assistance Team 158 (sorry for the poor spelling) I could become quietly assimilated into the community there and hopefully use their resources to find out where you guys were--at least that was the concept--ask the Chief of Supply at Second AirForce at the time, we worked on the concept together.

In short, the leak was thought to be in the U.S. and now appears to have been inside the Prime Minister's Office in Siagon--but who knows. Point is, our man is still there and I and many others, want him back! As I once walked Vietnam alone, I can do the same in Iraq.

While alone in my concept this time--i.e. no official support, I have as one might expect filed reports at the appropriate Agency on observations inside Iraq after my travels. Likewise, my sole reason for this and sole activity while there, will be to recover Speicher's remains.

Will you please obtain the necessary "best guess" of our Navy as to where Speicher went down and if you feel like involvement, either you lead the mission and I'll carry your suitcase or more properly, you give me the information and if we are successful, you meet us at the Jordan border.

Will you please think through options? If nothing else, I'll do the complete act, solo alone. However, might our side loan a Suburban (4 wheel drive truck) and a little support? I am totally willing and able to do the act alone, I grew up in Alaska and am used to both wilderness and operating alone.

In closing: I too was at Keesler AFB Hospital from injury in Vietnam (no I wasn't on the 5th floor--only joking) when you fellows were sent there. As you may recall, we met in passing a number of times and renewed our very brief acquaintance at the All Star Salute to President Reagan.

These days I'm very active in Republican Politics. I'm an Honorary Board Member of the Beverly Hills Republican Club and involved in many other projects as well. My point being, if we don't give the youth of America something to admire, Madona and Jim Carry (the actor) will be what they think is important in America.

Come on board John, we are old War Horses and knowing what we

are, we should always answer the Fire Bell when it rings.

I'll be happy to travel to Arizona or Washington to discuss the matter. Obviously, if I was arround President Reagan a bit, I'm at least simi-house broken and promise to not embarass you in any manor--I'll leave Ronstadt's band members home as no music will be done.

Respectfully,

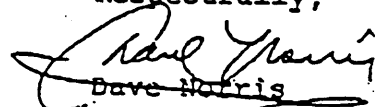
Dave Morris



2400 DEFENSE PENTAGON
WASHINGTON, DC 20301-2400



30 DEC 1996
In reply refer to:
I-96/54196

Mr. Richard Gustafson

[REDACTED]

(b)(6)

Dear Mr. Gustafson:

Thank you for your recent letter to Senator Connie Mack concerning the status of Lieutenant Commander Michael S. Speicher. Since our agency, the Defense Prisoner of War/Missing Personnel Office, is the Department of Defense (DoD) agency responsible for the prisoner of war/missing in action issue, Senator Mack asked that we respond to you.

Commander Michael Speicher's F/A-18 aircraft was shot down on January 17, 1991, during the Persian Gulf War. He is listed as killed in action/body not recovered (KIA/BNR). KIA/BNR reflects an accurate accounting status as determined by the Secretary of the Navy. However, in our commitment to bring home or account for each and every American lost due to hostile action, we continue to investigate and pursue every avenue toward possible repatriation of his remains. His crash site was located west of Baghdad in 1994.

In December 1995, the DoD dispatched investigators from the United States Army Central Identification Laboratory in Hawaii and the United States Navy to Jordan to form the nucleus of a team lead by the International Committee of the Red Cross. The team entered Iraq with the permission of the Iraqi Government, located the crash site, and conducted a thorough investigation. Information found during the investigation is being analyzed and will be released publicly once the investigation is complete and the family has been informed.

I hope this information is useful. Should you have any further questions, please contact our office.

Sincerely,

Charles W. Henley
Special Assistant
for Legislative Affairs
Defense POW/MIA Office

cc:
Senator Mack
Navy Casualty
CILHI



United States Senate

WASHINGTON, DC 20510-0904

OFFICE OF THE
SECRETARY OF DEFENSE

1996 DEC 12 AM 9:11

December 3, 1996

Ms. Deborah R. Lee
Assistant to the Secretary for Legislative Affairs
U.S. Department of Defense
The Pentagon, Room 3E966
Washington, D.C. 20231

Dear Ms. Lee:

Enclosed please find correspondence from Richard H. Gustafson.

I would greatly appreciate any reply your office can give on this inquiry. You may respond directly at the following address:

Richard H. Gustafson

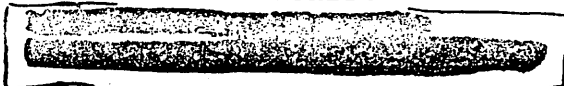

(b)(6)

Additionally, please send a copy of your response to Casey Otis at 517 Hart Senate Office Building, Washington, D.C. 20510.

Thank you for your time and consideration of this request.

Sincerely,

A handwritten signature in cursive script that reads "Connie Mack".

Connie Mack
United States Senator

CM/kco

Enclosure

96/54196
U17502 196

170
Casey

Nov. 12, 1996

Senator Connie Mack
United States Senate
Washington, DC 20510-0904

Dear Senator Mack,

Enclosed is a copy of the reply I received
From your office in 1994. Given the positive
statement in Paragraph 2, please provide me
with an up-date on the following serviceman,
for whom I have seen a POW/MIA bracelet:

Michael S. Speicher
U.S. Navy
16Jan91 Iraq

Thank you, in advance, for this information.

Sincerely,



Richard H. Gustafson



(b) (6)

st in the
encounters.

of all troops
(no American

owing how you feel
n the United States

cerely,

Connie Mack
United States Senator

Copy received this way.
CCO has same copy.

United States Senate

WASHINGTON, DC 20510-0904

January 5, 1994

Richard H. Gustafson

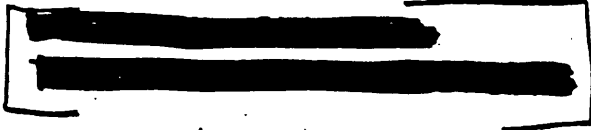

(b) (6)

Dear Mr. Gustafson,

Thank you for contacting me regarding your interest in the possibility of American POW's from our recent military encounters.

The Department of Defense has a full accounting of all troops deployed in both the Gulf war and in Somalia. There are no American troops listed as missing in action.

Again, thank you for getting in touch with me. Knowing how you feel on key issues helps me better represent all Floridians in the United States Senate.

Sincerely,

A handwritten signature in cursive script that reads "Connie Mack".

Connie Mack
United States Senator

CM/kmk



INTERNATIONAL
SECURITY AFFAIRS

2400 DEFENSE PENTAGON
WASHINGTON, D.C. 20301-2400



24 FEB 1997

In reply refer to:
I-96/19743

Honorable Rod Grams
United States Senator
2013 2nd Avenue North
Anoka, MN 55303

Dear Senator Grams:

Thank you for your recent letter on behalf of Mr. Richard Daly. Mr. Daly is requesting additional information concerning the shutdown of Navy Lieutenant Commander Michael Speicher during the Persian Gulf War. Our office is pleased to respond.

Mr. Daly first asks if there is any evidence that Commander Speicher survived his crash. At present, we do not have any evidence that he survived his loss incident. Our specialists have investigated the probable crash site of Commander Speicher's F/A-18. Evidence from this site is undergoing analysis and will be released when the investigation is complete and Commander Speicher's family has been fully informed.

Mr. Daly's final question is whether any pilot distress symbols were found near the crash site. Again, we do not possess any evidence that evasion codes assigned to Commander Speicher were located near his crashsite.

Thank you for the opportunity to be of assistance to you. Your interest and support in this important issue is appreciated.

Sincerely,

James W. Wold
Deputy Assistant Secretary of Defense
(POW/Missing Personnel Affairs)

cc:
Navy casualty ✓
Secretary of the Navy



140
3000

SJS 98-00048

6 January 1998

DISTRIBUTION C PLUS J-1,
J-3, J-5, OCJCS/LA/LC

SECRETARY, JOINT STAFF DIRECTIVE

on

LETTER FROM CONGRESSMAN VENTO TO SECDEF REGARDING MISSING
NAVY F-18 PILOT LCDR MICHAEL SCOTT SPEICHER

The attached correspondence is circulated for information.

Joint Secretariat

62

 JM

 KC

 MS

 FYI

1/14
 1/13
 1/16
 P6A
 P6G
 P6S
 P6S1
 P6S2
 P6S3
 P6S4
 P6N
 P62

DISTRICT OFFICE:
GALTER PLAZA
175 FIFTH ST., E.
RM. 727, BOX 100
ST. PAUL, MN 55101
(612) 224-4500

Congress of the United States

House of Representatives

Washington, DC 20515-2304

1997 DEC 12 PM 12:07

December 10, 1997

The Honorable William Cohen
The Secretary Of Defense
1000 Defense Pentagon
Washington, D.C. 20301-1000

Dear Secretary Cohen:

I am writing to express my concerns regarding the status of missing Navy F-18 pilot Lieutenant Commander Michael Scott Speicher, the first American lost in the 1991 Persian Gulf War. I request that you inform me of the status of this incident, and an investigation into the status of the only member of the United States military Persian Gulf Conflict whose fate remains unknown to this day.

I know you share my concern with the status of missing military personnel who have served in the United States Armed Forces with honor and courage. We have a moral obligation to resolve this issue to the best of our ability. Therefore, I strongly urge you to investigate and attempt to resolve this matter without delay.

Your attention to this matter will provide answers to the family of the fallen Navy pilot, and to our American military servicemen and women. Thank you for your assistance on this particular case, and I look forward to hearing from you.

Sincerely,

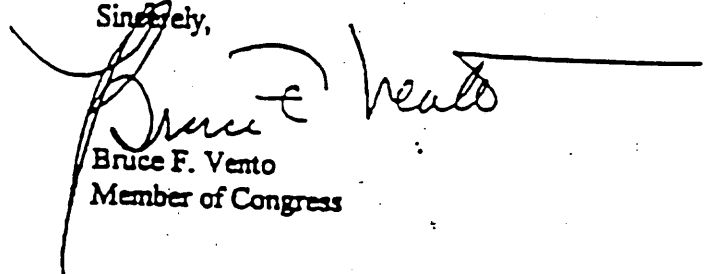

Bruce F. Vento
Member of Congress

BFV:ms

U20829 197



INTERNATIONAL
SECURITY AFFAIRS

OFFICE OF THE ASSISTANT SECRETARY OF DEFENSE

2400 DEFENSE PENTAGON
WASHINGTON, D.C. 20301-2400



13 FEB 1998
In reply refer to:
I-98/60420

Honorable John McCain
United States Senate
Attn: Dan Twining
241 Russell Senate Office Building
Washington, DC 20510

Dear Senator McCain:

Thank you for your January 9, 1998, letter to the former Deputy Assistant Secretary of Defense (DASD) for POW/Missing Personnel Affairs, James W. Wold, on behalf of Collin Smith and David L. Parker. Mr. Smith and Mr. Parker seek information about Navy Lieutenant Commander Michael Scott Speicher who was killed in action during the Persian Gulf War but whose remains have not been recovered.

Commander Speicher was lost on January 17, 1991, when his F/A-18 aircraft was downed in Iraq during Operation Desert Storm. The Secretary of the Navy, based on the information known to him at the time of Commander Speicher's loss, assigned his casualty status as KIA-BNR. The Department of the Navy continues to carry Commander Speicher in this status because it reflects the most accurate information to date regarding his fate. However, given our Government's unwavering commitment to obtain the fullest possible accounting for Americans lost due to hostile action, the case was never officially closed. The discovery of intelligence information several years after the loss incident provided our first new clues and allowed us to begin an investigation. Since 1993, we have used all appropriate analytical, diplomatic, intelligence, and scientific means available to mount a comprehensive investigation.

In December 1995, working through the International Committee of the Red Cross, Defense investigators from the Navy and the Army Central Identification Laboratory in Hawaii (CILHI) entered Iraq, with the permission of the Iraqi Government, and conducted a thorough investigation of Commander Speicher's previously unlocated crash site. Although we did not recover Commander Speicher's remains at the crash site, information and aircraft wreckage were recovered which has allowed us to continue our investigation.

Commander Speicher's family has been kept fully informed of the DoD efforts and the information we have obtained. The family has expressed publicly their satisfaction with our actions and has requested information not be released to the public in order to protect their privacy and the integrity of any potential new lead. In addition, as our investigation has developed, my office has kept the appropriate congressional oversight committees apprised.



The men and women of this office gratefully appreciate the continuous concern and consistent support you and your colleagues demonstrate for our efforts to achieve the fullest possible accounting. I hope this information is helpful in responding to Mr. Smith and Mr. Parker. So that they may stay abreast of our operations throughout the world, I recommend you have them contact our Internet site at www.dtic.mil/dpmo. If you have further questions, please contact my office.

Sincerely,

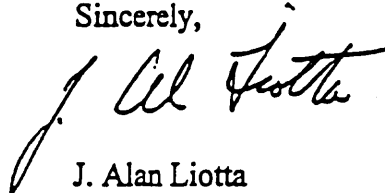
A handwritten signature in black ink, appearing to read "J. Alan Liotta". The signature is written in a cursive style with a large initial "J" and a long horizontal stroke extending to the right.

J. Alan Liotta
Acting Deputy Assistant Secretary of Defense
(POW/Missing Personnel Affairs)

cc:

Navy casualty office



DEFENSE PRISONER OF WAR/MISSING PERSONNEL OFFICE
2400 DEFENSE PENTAGON
WASHINGTON, DC 20301-2400

17 MAR 1998

In reply refer to:
I-98/63095

Mr. Woody Nickels

[REDACTED]
[REDACTED]

(b)(6)

Dear Mr. Nickels:

Thank you for your February 25, 1998, letter to the Defense POW/Missing Personnel Office. As a former roommate and friend of his, you request information on Navy Lieutenant Commander Michael Scott Speicher who was killed in action during the Persian Gulf War, but whose remains have not been recovered.

Commander Speicher was lost on January 17, 1991, when his F/A-18 aircraft was downed in Iraq during Operation Desert Storm. The Secretary of the Navy, based on the information known to him at the time of Commander Speicher's loss, assigned his casualty status as killed in action-body not recovered (KIA-BNR). The Department of the Navy continues to carry Commander Speicher in this status because it reflects the most accurate information to date regarding his fate. However, given our Government's unwavering commitment to obtain the fullest possible accounting for Americans lost due to hostile action, the case was never officially closed. The discovery of intelligence information several years after Commander Speicher's loss incident provided our first new clues and allowed us to begin an investigation. Since 1993, we have used all appropriate analytical, diplomatic, intelligence, and scientific means available to mount a comprehensive investigation.

In December 1995, working through the International Committee of the Red Cross, Department of Defense (DoD) investigators from the Navy and the Army Central Identification Laboratory entered Iraq, with the permission of the Iraqi Government, and conducted a thorough investigation of Commander Speicher's previously unlocated crash site. Although we did not recover his remains at the crash site, information and aircraft wreckage were recovered which has allowed us to continue our investigation.

To ensure the integrity of our ongoing investigation into Commander Speicher's case and out of deference to his family's request for privacy, we cannot provide you with details of this case. Be assured, however, that Commander Speicher's family is being kept fully informed of our efforts and the information we obtain.



The men and women of this office gratefully appreciate your concern for your friend, Commander Speicher. We are committed to accounting for all our nation's unaccounted-for servicemen. To stay abreast of our operations throughout the world, I recommend you contact our Internet site at www.dtic.mil/dpmo.

Sincerely,

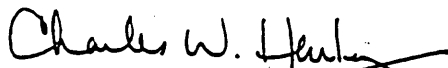

Charles W. Henley
Legislative and External Affairs
Defense POW/Missing Personnel Office

cc:
Navy casualty office



DEFENSE PRISONER OF WAR/MISSING PERSONNEL OFFICE
2400 DEFENSE PENTAGON
WASHINGTON, DC 20301-2400

06 MAY 1998

In reply refer to:
I-98/66907

Office of Senator Kay Bailey Hutchinson
Attention: Mr. John Gonzales
10440 North Central Expressway
Suite 1160, LB 606
Dallas, TX 75231

Dear Mr. Gonzales:

Thank you for your March 17, 1998, letter to the Navy's legislative liaison office on behalf of Mr. Woody Nickels who is requesting information on Navy Lieutenant Commander Michael Scott Speicher who was lost during the Gulf War. Your letter was forwarded to our office since we are the Department of Defense (DoD) agency responsible for this issue, and we are pleased to respond. Per your request, we have enclosed a copy of your letter to us with its corresponding attachments.

As we informed Mr. Nickels in our March 17, 1998, letter to him on this issue, Commander Speicher was lost on January 17, 1991, when his F/A-18 aircraft was downed in Iraq during the Persian Gulf War. The Secretary of the Navy, based on the information known to him at the time of Commander Speicher's loss, assigned his casualty status as killed in action-body not recovered. The Department of the Navy continues to carry Commander Speicher in this status because it reflects the most accurate information to date regarding his fate. However, given our Government's unwavering commitment to obtain the fullest possible accounting for Americans lost due to hostile action, the case was never officially closed. The discovery of his crash site several years after the loss incident provided our first new clues and allowed us to begin an investigation. Since 1993, we have used all appropriate analytical, diplomatic, intelligence, and scientific means available to mount a comprehensive investigation.

In December 1995, working through the International Committee of the Red Cross, Defense investigators from the Navy and the Army Central Identification Laboratory in Hawaii (CILHI) entered Iraq, with the permission of the Iraqi Government, and conducted a thorough investigation of Commander Speicher's crash site. Although we did not recover Commander Speicher's remains at the crash site, information and aircraft wreckage were recovered which has allowed us to continue our investigation.

Commander Speicher's family has been kept fully informed of DoD efforts and the information we have obtained. The family has expressed publicly their satisfaction with our



actions and has requested information not be released to the public in order to protect their privacy and the integrity of any potential new lead. In addition, as our investigation has developed, our office has kept the appropriate congressional oversight committees apprised.

I hope this information is helpful. Please do not hesitate to contact us if you have further questions on this issue.

Sincerely,

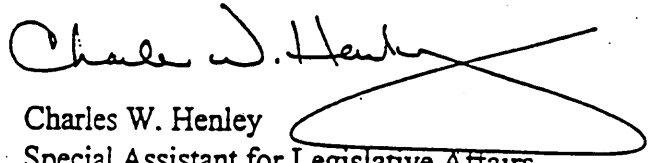
A handwritten signature in cursive script that reads "Charles W. Henley". The signature is written in black ink and is positioned above the typed name and title.

Charles W. Henley
Special Assistant for Legislative Affairs
Defense POW/Missing Personnel Office

Enclosure:
As stated

cc:
Navy casualty office



06 MAY 1998

In reply refer to:
I-98/66906

Honorable Dick Arney
United States Representative
9901 Valley Ranch Parkway, East
Suite 3050
Irving, TX 75003

Dear Representative Arney:

Thank you for your March 25, 1998, letter to the Navy's legislative liaison office on behalf of your constituent, Mr. Woody Nickels. Mr. Nickels requests information on Navy Lieutenant Commander Michael Scott Speicher who was killed in action during the Persian Gulf War, but whose remains have not been recovered. Your letter was forwarded to our office since we are the Department of Defense (DoD) agency responsible for this issue. We are pleased to provide you the following information for your use in responding to Mr. Nickels.

As we informed Mr. Nickels in our March 17, 1998, letter to him on this issue, Commander Speicher was lost on January 17, 1991, when his F/A-18 aircraft was downed in Iraq during the Persian Gulf War. The Secretary of the Navy, based on the information known to him at the time of Commander Speicher's loss, assigned his casualty status as killed in action-body not recovered. The Department of the Navy continues to carry Commander Speicher in this status because it reflects the most accurate information to date regarding his fate. However, given our Government's unwavering commitment to obtain the fullest possible accounting for Americans lost due to hostile action, the case was never officially closed. The discovery of his crash site several years after the loss incident provided our first new clues and allowed us to begin an investigation. Since 1993, we have used all appropriate analytical, diplomatic, intelligence, and scientific means available to mount a comprehensive investigation.

In December 1995, working through the International Committee of the Red Cross, Defense investigators from the Navy and the Army Central Identification Laboratory in Hawaii (CILHI) entered Iraq, with the permission of the Iraqi Government, and conducted a thorough investigation of Commander Speicher's crash site. Although we did not recover Commander Speicher's remains at the crash site, information and aircraft wreckage were recovered which has allowed us to continue our investigation.

Commander Speicher's family has been kept fully informed of DoD efforts and the information we have obtained. The family has expressed publicly their satisfaction with our



actions and has requested information not be released to the public in order to protect their privacy and the integrity of any potential new lead. In addition, as our investigation has developed, our office has kept the appropriate congressional oversight committees apprised.

Representative Arney, your continued concern and support for this important issue are gratefully acknowledged and appreciated by the men and women of this office. So that Mr. Nickels may stay abreast of our current operations throughout the world, I recommend you have him contact our Internet site at www.dtic.mil/dpmo. If you or your staff have further questions regarding this issue, please do not hesitate to contact our office.

Sincerely,

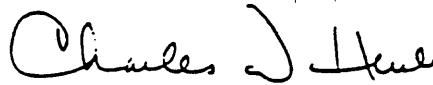

Charles W. Henley
Special Assistant for Legislative Affairs
Defense POW/~~Missing Personnel~~ Office

cc:

Navy casualty office

Department of Defense
Office of the Secretary
International Secretary Affairs

Date: 6/23

Cindy
Cindy:

Just wanted to follow-up briefly on our phone conversation. Enclosed is the report we provided to the Iraqis via the ICRC. In regards the FOIA requests, DoD has not released any documents. The overall requests are still pending. My understanding is that when they elect to respond, we will receive in advance for approval a package of documents. Should that occur, I would like to get a copy of this package to you for your thoughts/concerns before we officially respond. Please do not hesitate to ask if there is anything I can do for either of you.



J. Alan Liotta
Deputy Director
Defense POW/Missing Personnel Office



DEFENSE PRISONER OF WAR/MISSING PERSONNEL OFFICE
2400 DEFENSE PENTAGON
WASHINGTON, DC 20301-2400

In reply refer to:
I-97/21681

MEMORANDUM FOR The International Committee Of The Red Cross (ICRC)
(Operations Division, Attn: Michelle Cageneaux)

FROM: Deputy Assistant Secretary of Defense for POW/Missing Personnel Affairs
Prepared by LCDR K. Wilson, OASD/ISA-DPMO

SUBJECT: Results of the Investigation of U.S. F/A-18 Loss in Western Region of Iraq

Purpose. For your benefit and that of the Iraqi personnel who assisted us on the humanitarian operation to confirm the fate of LCDR Michael S. Speicher, this report provides a status of findings from the excavation of his crash site.

Background

On January 16, 1991 at 0136 hours, LCDR Speicher launched in the first attack wave associated with Operation Desert Storm. At approximately 2 hours and 15 minutes into the mission, LCDR Speicher's wingman reported seeing an explosive flash in the vicinity of Speicher's F/A-18 aircraft. The U.S. Government has yet to determine the fate of LCDR Speicher, and to return him or his remains to his family.

In March 1991, the Republic of Iraq (ROI) repatriated remains to the U.S. that they associated with the name of "Michael". DNA analysis subsequently determined they were not those of LCDR Speicher.

On March 1, 1995, the ROI agreed to a joint ICRC/ROI humanitarian recovery effort to determine the fate of the pilot. The team included experts from the U.S. Central Identification Laboratory in Hawaii (CILHI). On December 10, 1995, a team of ICRC officials and CILHI personnel traveled to the suspected crash site to begin a recovery operation for the remains of LCDR Speicher. The crash site was located in the vicinity of Tulul Ad Dulaym, Wadi Thumayl, Republic of Iraq.

Description of Crash Site

The field investigation was conducted on December 10 - 16, 1995. Wreckage of the F/A-19 aircraft was discovered within three hours driving time southwest from Baghdad. The mishap site was located less than 30 kilometers to the south of a major East-West highway in a desert region with no substantial natural landmarks. Several Bedouin camps were visible to the north and northwest of the crash site, with numerous dirt trails radiating out from the camps to the paved roads.

Large fragments of recognizable aircraft wreckage were present on the desert floor (photos 1-3, enclosure 5). As there was no significant crash crater and the aircraft wreckage showed minimal fragmentation, it was determined to be consistent of a terminal velocity, high angle and low power impact. The wreckage consisted of the nose gear and 20mm gun, representing the nose of the aircraft; the wings; engines; and tail rudders and stabilizers (enclosure 3). Ordnance was still located at the crash site (photo 13, enclosure 5). The following major components were not with the airframe:

- 1) Wing fuel drop tank - found 4000 meters north
- 2) Center line fuel drop tank - found 2500 meters north
- 3) Canopy - found 670 meters northeast
- 4) The entire cockpit and instrument bay section, forward of the wings to just aft of the gun - not found

Subsequent post crash fire and erosion had contributed to the breakdown and disintegration of the structural elements manufactured from composite material, such as the wings.

Aircraft Wreckage Findings

Excavation was initiated in the area of the cockpit, an area which showed signs of recent manual digging. The ground was excavated to a depth of 50 centimeters to culturally sterile soil. Excavation continued along the aircraft's midline until it became apparent that no significant cockpit debris, pilot-related materials, or human remains were present (photos 4-9, enclosure 5).

Analysis of the engines concluded that both engines were in relatively good shape. Based on post crash analysis of the photographs of engine components, the qualified assumption is the engines had shut down in flight. The wing and centerline drop tanks found north of the crash site had their pylons still attached (photos 10-11, enclosure 5). The pylons were torn from the fuselage inflight, indicative of excessive aerodynamic forces over a short period of time that were consistent with the aircraft being subject to a violent spin.

The cockpit canopy, found northeast of the wreckage, had been jettisoned. When first examined, the frame was standing vertically on a small rise where it apparently had been placed by the Bedouins to serve as a local landmark (photo 12, enclosure 5). Both canopy jettison rocket motors had been fired, which produced burn marks even and complete. Given available evidence, mishap investigators determined that the pilot initiated the jettison.

Archaeological Findings

During the recovery effort, the team surveyed a circle of approximately 10 kilometers in diameter centered around the crash site. The team anthropologist shovel-tested several low rock piles located around the wreckage in search of a possible grave site (photo 14, enclosure 5). None appeared to be associated with a subsurface disturbance within the last ten years. No human remains were recovered at either the crash site or the several small stone piles examined. No pilot-related materials were recovered at the crash site. Cockpit-related items found during excavation consisted of only two switches and one warning indicator light.

During the excavation, Iraqi officials present at the site notified the team that a young Bedouin boy had encountered a flight suit while herding his sheep. Several team members traveled to a small rise approximately 3.5 kilometers northeast of the crash site and discovered a U.S. flight suit lying on the surface. The team began to systematically surface search the adjoining desert, but were not allowed to directly interview the child. Ultimately, additional pilot-related materials were recovered approximately 1 kilometer to the east of where the flight suit was located:

- 1) Six fragments of anti-G suit material
- 2) An ejection-seat upper-leg garter fragment
- 3) Three survival-raft fragments
- 4) A survival-kit flare
- 5) A parachute-riser fragment

Final Analysis

The flight suit is consistent with the one worn by LCDR Speicher. Pieces of the Aviation Life Support System (ALSS) equipment found suggest that LCDR Speicher ejected from his aircraft. The flight suit and all ALSS equipment recovered were cut with a sharp object; they also had blood stains, but none suggesting massive external bleeding (photo 15-16, enclosure 5). No human remains were found in the vicinity of the crash site. The recovery team reported that the cockpit area of the aircraft, including ejection-seat components, was removed prior to the excavation of the site by the ICRC/ROI team excavation. Pending new information, no further excavation is required at the crash location.

Enclosure(s):

1. General location of crash site.
2. Topographic location of project area and relative location of the recovered materials.
3. Sketch map of site.
4. List of photographs.
5. Photographs (16).

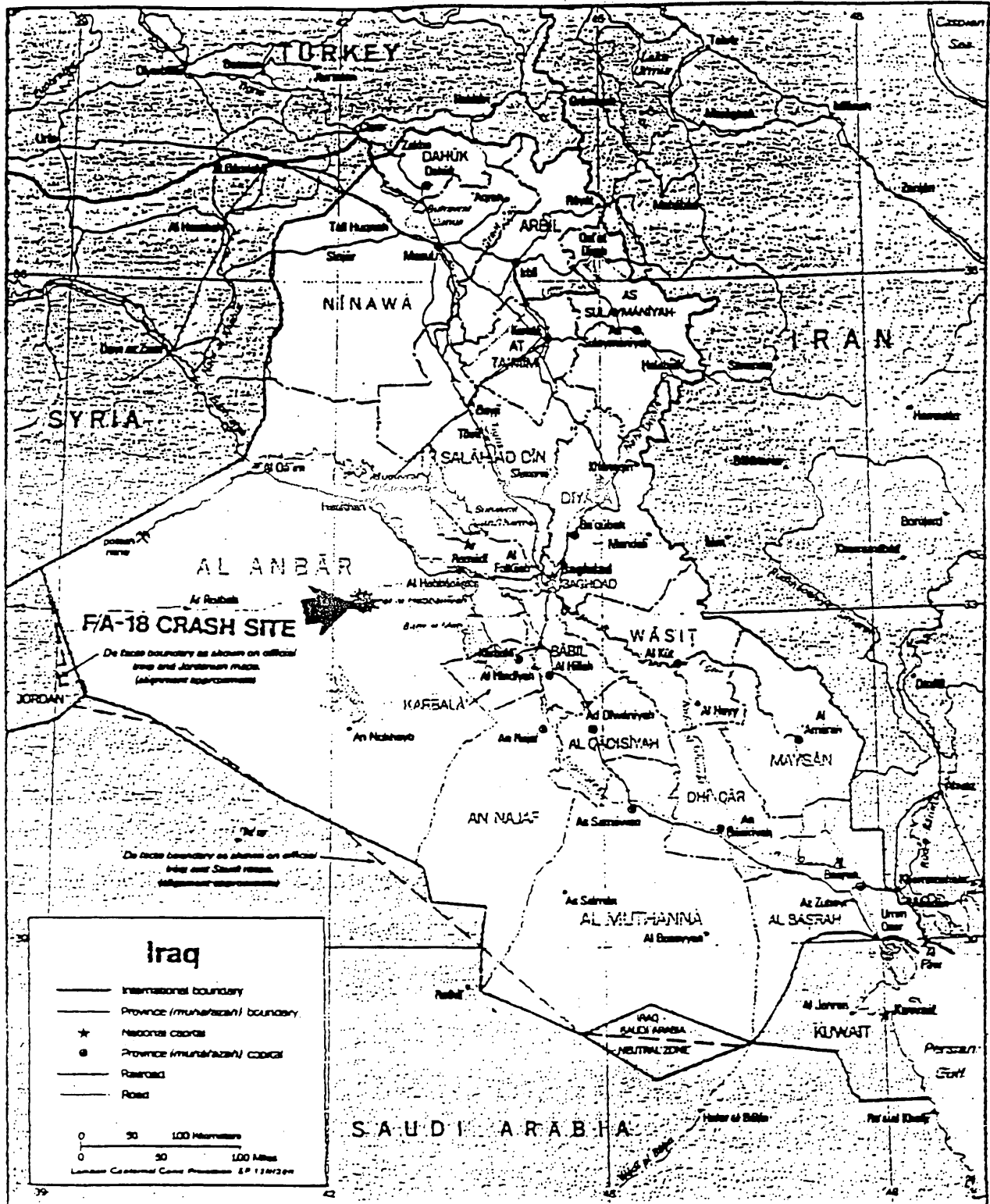

Enclosure 1

General Location of Project Area

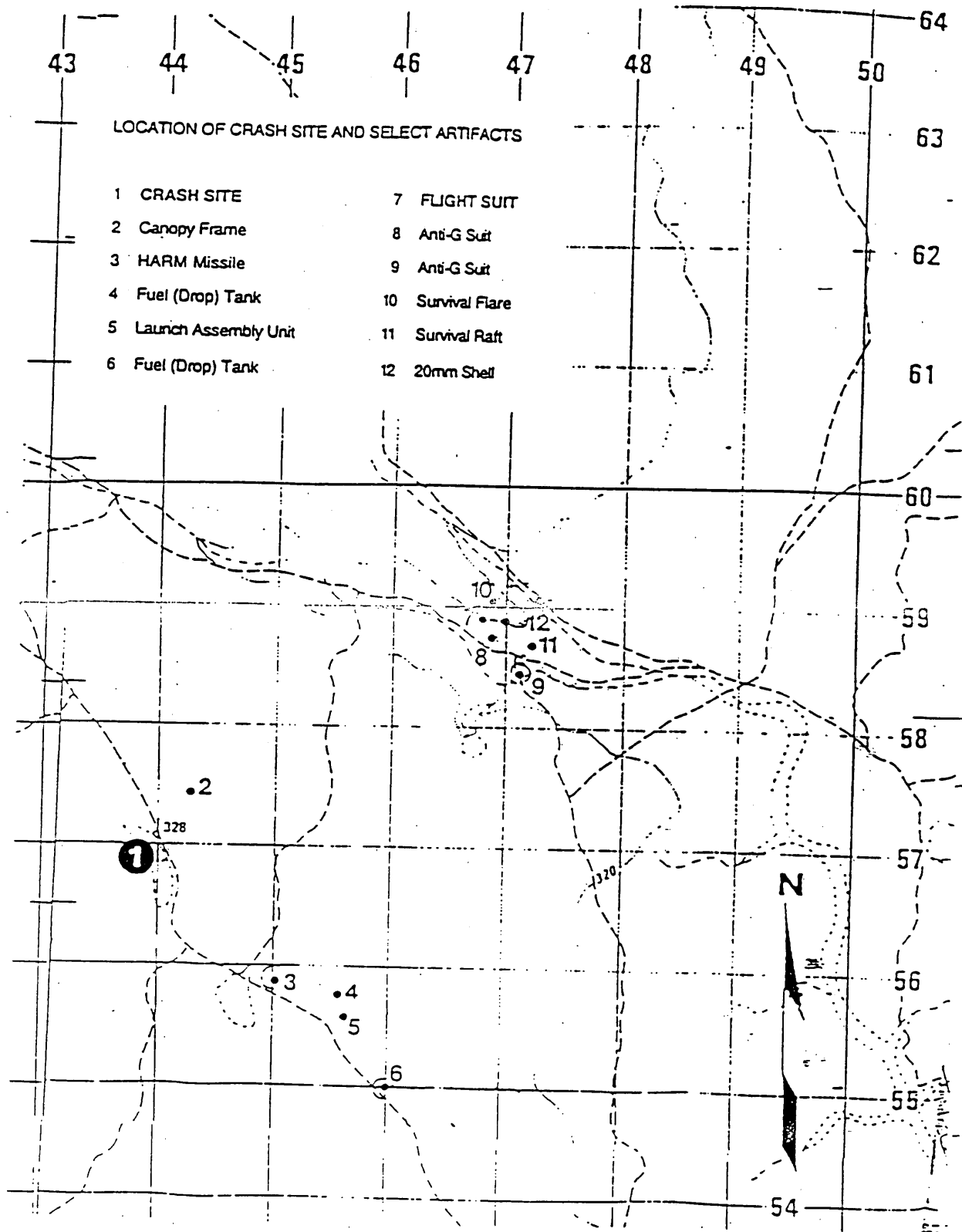

Tulul Ad Dulaym; Edition I-DMA; Series K743; Sheet 4456 II
 Scale 1:50,000; Horizontal Datum: World Geodetic System, 1994

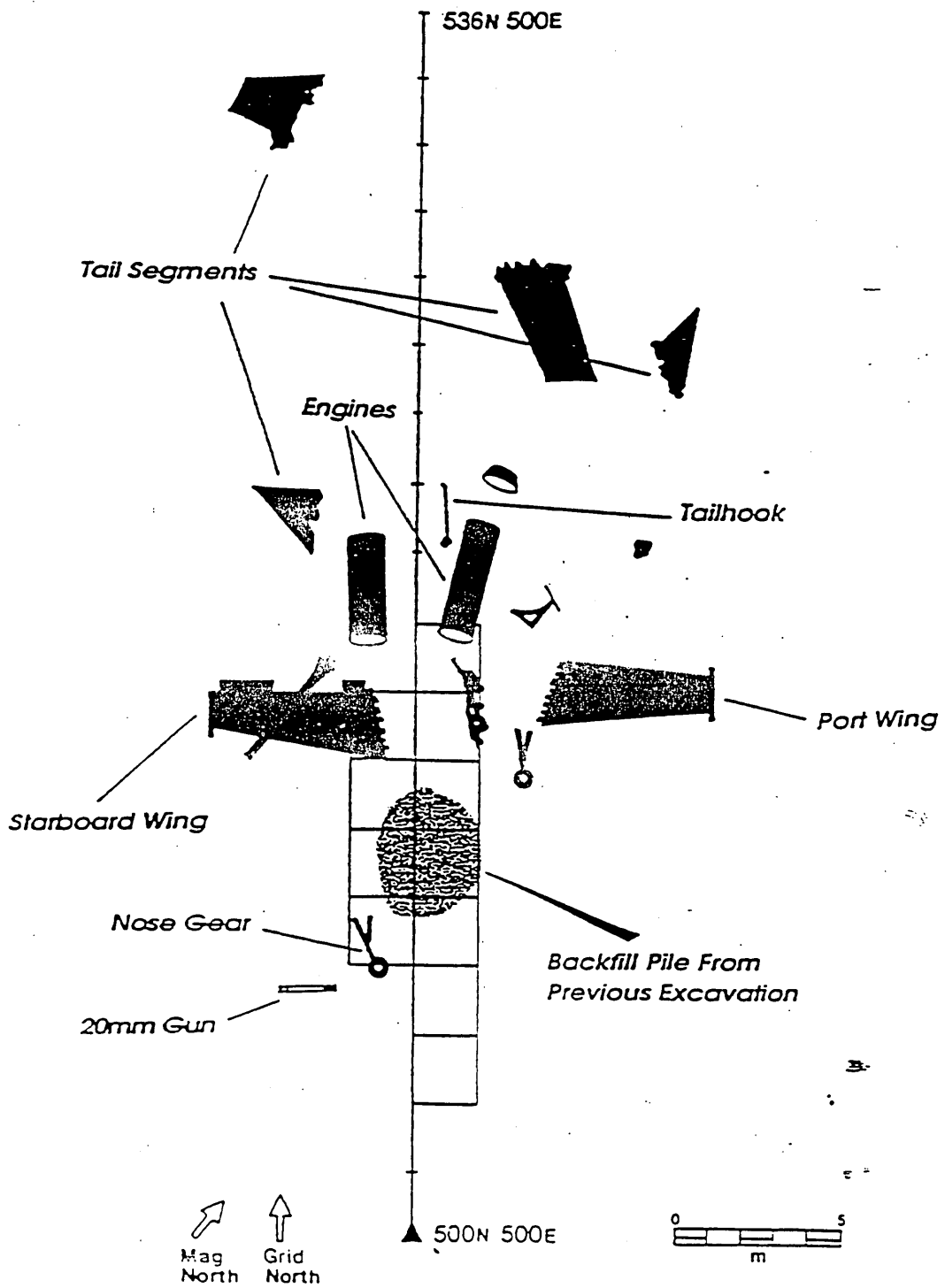

Enclosure 3

Sketch Map of Site

LIST OF PHOTOGRAPHS

1. Crash site as viewed upon arrival (looking northeast).
2. Close-up view of crash site prior to beginning recovery (looking north). Red flags mark unexploded ordnance.
3. Close-up view of crash site (looking northwest). Arrow points to where location of cockpit should be.
4. Excavation of units in cockpit area (looking north).
5. Close-up view of soil profile showing artifact-bearing stratum, burned layer, and underlying incident-sterile stratum (looking at grid west wall).
6. View of completed excavation (looking grid north).
7. Close-up view of nose gear and 20 mm gun.
8. Vertical stabilizer.
9. Excavation in progress (looking south). Port wing in foreground.
10. One of the fuel (drop) tanks located to the east of the crash site.
11. Other fuel (drop) tank located to the east of the crash site.
12. Canopy frame as first viewed by the recovery team.
13. Ordnance.
14. Rock pile located immediately east of the canopy frame. The construction, form, and size of this pile mirrors those of numerous other features found in the project area.
15. Upper portion of flight suit found. Detail shows definite cuts in material.
16. Full flight suit modeled to show completeness.

SUMMARY OF FACTS AND CIRCUMSTANCES
LCDR MICHAEL S. SPEICHER, USN/ [REDACTED]

(b)(6)

- I. Other Crew Members
None
- II. Day or night/Date/Weather
Night (0352 local)/17 January 1991/No report on weather
- III. Mission
First night strike mission in vicinity of Baghdad, Iraq
- IV. Aircraft loss - Location/Terrain
Aircraft failed to check in upon completion of strike.
Approximate position N33.00, E042.20 per VFA-81, N33.10,
E044.40 per DIA/Overland
- V. Aircraft Type/Unit/Call sign/Single or multiple place
F/A-18/ VFA-81/AA-403/ Pilot of single seat aircraft
- VI. Communications from aircraft/member
Last voice communication was after completion of refueling and
prior to entering hostile territory.
- VII. Loss observed/Witnesses
During debriefing, one air wing pilot reported having possibly
seen an aircraft hit by air-to-air or surface-to-air fire,
explode and subsequently crash. It cannot be positively
determined if this was AA-403, but no other aircraft were
lost during this strike.
- VIII. Search
Search efforts initiated. There were no visual or audible
signals.
- IX. Immediate assessment
No firm information as to the fate of the pilot. Originally
reported as KIA by Secretary of Defense Cheney.
- X. Intelligence
Debrief of enemy POWs provided no information on this incident
which would indicate LCDR Speicher's survival.
- XI. Propaganda
None
- XII. Repatriated POW information
No U.S. or Allied POWs held any information which would indicate
LCDR Speicher's survival.
- XIII. Status of Remains
Conclusive evidence proved the remains provided by Iraqi
government were not those of LCDR Speicher.

REPLY TO
ATTENTION OF

AFIP-OAFME

15 May 1991

MEMORANDUM FOR DEPARTMENT OF THE NAVY, BUREAU OF MEDICINE AND
SURGERY, ATTN: MORTUARY AFFAIRS BRANCH,
WASHINGTON, DC 20372-5120

SUBJECT: DNA Testing Of Desert Storm Remains - DS1-256

1. DNA testing has been completed on the remains of DS1-256 that were received at the Dover Port Mortuary on 23 March 1991. Results confirm that those remains are not those of LCDR Michael Scott Speicher, U.S. Navy, [REDACTED] who was reported missing in action on 17 January 1991, while in support of Operation Desert Storm. (b)(6)

2. The remains identified as DS1-256 consisted of partially decomposed portions of upper torso tissue, mainly skin, which were recovered by Iraq officials and returned to United States control through the Red Cross. No additional information was available from the Iraq government as to why these remains were believed to be those of LCDR Speicher.

3. Comparison of DNA tests from the tissue sample of DS1-256 were made with DNA results obtained from sera of LCDR Speicher stored (drawn July 1990) in the Department of Defense HIV repository, hair clippings from an electric shaver belonging to LCDR Speicher, and hair from a deodorant bar belonging to LCDR Speicher. DNA results were also compared with DNA tests run on oral swabs and plucked hairs from Joanne A. Speicher (wife), Michael S. Speicher (son), and Meghan L. Speicher (daughter).

4. Initially difficulty was encountered obtaining genomic DNA test results from the DS1-256 due to sample degradation, but eventually adequate results were obtained from plucked hair samples found on the tissue. Further genomic system analysis are being completed. We initiated mitochondrial DNA testing when genomic DNA testing was proving difficult; this is still on-going.

5. The DNA results obtained permitting this exclusion were based on Polymerase Chain Reaction (PCR)-based amplification "AmpFLP" testing using the human gene probe, pMCT 118, by Marcia Eisenberg, PhD, at the Roche Biomedical Laboratories, Inc., Research Triangle Park, North Carolina. The results are as follows:

AFIP-OAFME

SUBJECT: DNA Testing Of Desert Storm Remains - DS1-256

Specimen:

DS1-256 remains
Michael S. Speicher (Son)
Meghan L. Speicher (Daughter)
Joanne A. Speicher (Wife)

Alleles:



(b)(6)

These results were produced on a polyacrylamide gel which yielded strong, unambiguous, technically-adequate results free of background noise.

(b)(6) 6. Potential challenges with this testing have been addressed. This exclusion is not erroneous on the basis of measurement imprecision, as the bands involved are not in close proximity to each other but are in different regions of the gel. The exclusion is not erroneous on the basis of a "lost band" where the remains yielded a single homozygous band, because the pedigree constructed from Mrs. Speicher and the children indicates that LCDR Speicher has alleles [redacted] which are inconsistent with the [redacted] allele seen on the gel. Furthermore, the gel results are strong, clear, and free of background noise. The exclusion is not erroneous due to a mutational event, because the possibility that this would happen [redacted] is extremely unlikely. The exclusion is not erroneous due to contamination, as the postmortem sample for DNA testing was obtained by plucking hair from the skin sample of DS1-256, hence the DNA was obtained from deep within the specimen. Again, the results were unequivocal, with no hint of a second genotype in the background. [redacted]

7. These DNA test results definitely exclude LCDR Michael S. Speicher as the origin of those remains identified as DS1-256.

8. Any additional question concerning these test should be directed to MAJ(P) Victor Weedn, MC, USA, Chief, Armed Forces DNA Identification Laboratory, (202) 576-3288/2482 or (A) 291-3288/2482.

Richard C. Froede
RICHARD C. FROEDE, M.D.
Armed Forces Medical Examiner

MEMORANDUM FOR THE RECORD OF LCDR SPEICHER

6 May 91: Spoke to Dr. Weedon (AFME). He relayed that remains they had been testing DNA for a possibility of match with LCDR Speicher is definitely NOT LCDR Speicher's remains.

Remains consisted of scalp w/hair, metal (originally thought to be bone) and fragments. They were running it for a DNA sample originally without comparison. They were looking for two kinds of DNA: genomic and monochondrial (sp?). There are a lot more copies of monochondrial DNA and its easier to obtain, but they couldn't get this type DNA as a comparison from the children since it is only inherited from the mother. They had to contract with three other companies for some of DNA Testing. They had a lot of difficulty getting regular DNA testing out of sample. They knew their best chance was with monochondrial DNA, but they couldn't figure out how to do it.

They finally got genomic DNA from the remains. This was enough to get something now from the family.

They had the problem next of receiving oral swabs that turned out "clean" and had to go back to family for more, plus mother for reverse parenting.

From the razor, they were able to get hair shafts, but not roots. They needed roots for genomic DNA testing. Shafts only have monochondrial DNA. They are still processing for monochondrial DNA, but it will take a few weeks. Its not really used much.

HIV serum test proved negative. It had already been processed to remove white blood cells.

After obtaining new swabs, they were able to get a good set from family and from remains.

The hairs they used to get DNA sample from remains were plucked and roots used. Therefore sample was a clean result and well representative. He has a lot of confidence in it.

They got the same DNA result from both children, so there's no real chance of mistake on this.

Dr. Weedon said the remains are conclusively not LCDR Speicher. He can say they are a negative match with strong conviction. A positive result would not be easy to state so strongly.

They are running results for more evidence, but he doesn't really need them. Its just good lab practice and helps demonstrate the conclusion to other people.

Passed negative results to CAPT Arthur / LCDR Inlay.
Major Weedon's = (202) 576-3287/8.

MEMORANDUM FOR THE RECORD OF LCDR SPEICHER

29 APR 91: Called CACO, LCDR Salazar. Told him Navy ready to change status to KIA. Wanted to send CNP rep, CAPT Raebel to discuss efforts to date and change in status. CAPT Curtin, COMLATWING CO, personally visited Mrs. Speicher. Everyone decided there was no need for CAPT Raebel to visit Mrs. Speicher.

Mr. Canik from Armed Forces Medical Examiner called. Said they have a DNA fingerprint from the remains, but still need something to compare it to. Said HIV test blood sample was too well processed to get anything from it. Oral swabs turned up absolutely negative - which indicates to them the swabs were not taken correctly or the right ones not sent. They need to test the children and mother now in order to do reverse paternity testing. They were able to get hair follicles from personal items to compare with hair on remains, but this is a slow, unrefined process.

* Lt Col Bason (sp?) called from JMAO (CENTCOM Mortuary Affairs). He said they were working on trying to get a flight suit from ICRC that was possibly LCDR Speicher's. He mentioned the spelling ICRC had for his name was Mickel. He said the flight suit would be sent to Dover from Riyadh if they get it from ICRC. He is gone 1 May. NEW POC is Major John McClullan, USAF, AV 968-5835/6/7.

30 APR 91: LCDR Salazar called and confirmed no need for CAPT Raebel to visit. Status change requested for 22 May. Memorial service or funeral (if remains identified) planned for same day.

1 MAY 91: CDR Winney (Dover Mortuary) called. Said flight suit was a misnomer according to Col Bason.

- New POC @ CENTCOM Riyadh for questions on ICRC is
Col Ward # 011-966-1402-5521



OFFICE OF ASSISTANT SECRETARY OF DEFENSE
(PUBLIC AFFAIRS)

COMMUNICATIONS SECTION
PLEASE NOTE DAIL

IMMEDIATE RELEASE

December 14, 1995

No. 659-95
(703)695-0192(media)
(703)697-3189(copies)
(703)697-5737(public/industry)

**INTERNATIONAL COMMITTEE OF THE RED CROSS LEADS U.S.
INVESTIGATION INTO IRAQ**

The International Committee of the Red Cross, with the cooperation of the Government of Iraq, is leading a team, including U.S. experts, to investigate and excavate a crash site of a U.S. pilot lost in 1991 during the Gulf War. This mission is strictly a humanitarian effort to account for an American pilot whose remains have never been recovered.

Once United States officials had conclusive evidence of the crash in Iraq, they asked the ICRC in its capacity as a neutral intermediary to send a team to the crash site to search for remains and relevant evidence. The ICRC-lead team includes a U.S. anthropologist and life science technician from the U.S. Army's Central Identification Laboratory and aircraft crash investigators.

The team traveled to the crash site via Baghdad. Results will not be known until a complete analysis is concluded.

The U.S. Government remains committed to determining the fate, and if possible, repatriating the remains of any U.S. service member lost in conflict.

-END-

INTERNET AVAILABILITY: This document is available on DefenseLINK, a World Wide Web Server on the Internet, at <http://www.dtic.dla.mil/defenselink/>

Public Release Statement

The International Committee of the Red Cross, with the cooperation of the Government of Iraq, is leading a team, including U.S. experts, to investigate and excavate a crash site of a U.S. pilot lost in 1991 during the Gulf War. This mission is strictly a humanitarian effort to account for an American pilot whose remains have never been recovered.

Once United States officials had conclusive evidence of the crash site in Iraq, they asked the ICRC in its capacity as a neutral intermediary to send a team to the crash site to search for remains and relevant evidence. The ICRC-led team includes a U.S. anthropologist and life science technician from the U.S. Army's Central Identification Laboratory and aircraft crash investigators.

The team traveled to the crash site via Baghdad. Results will not be known until a complete analysis is concluded.

The U.S. Government remains committed to determining the fate and, if possible, repatriating the remains of any U.S. service member lost in conflict.

From: Mike Brock
Naval Aviation Depot
1126 Pocahontas St.
Norfolk, VA 23511-2195

To: Alan Liotta
OSD/DPMO
Suite 700B
1300 Clarendon Blvd.
Arlington, VA 22201

Dear Mr. Liotta:

I have been informed by Naval Air Systems Command, Washington, D.C. that your activity has requested some photographic, dimensional, and operational information regarding the Martin-Baker SJU-5A ejection seat used in earlier versions of the F/A-18A/B. I presume this information involves a mishap of some sort, however, since I have not spoken to you directly I cannot ascertain exactly what type of information you truly need. Therefore, I have only enclosed some general information regarding the operation of the SJU-5A ejection seat system.

Also, I have discussed this matter with an associate of mine, Mr. Peter Yost of the Naval Air Warfare Center, Warminster, PA and he will be sending some basic ejection seat dimensional information on my behalf.

I understand that photographic information is highly desired. Depending on the circumstances of the ejection or non-ejection, damage characteristics can vary greatly. We currently have some mishap photographic data and this could be helpful if the circumstances were similar to a mishap you may be investigating. I should also note that some of these photos are privileged information and cannot be released, but can be viewed if necessary.

If you have any further questions regarding Martin-Baker escape systems and need additional assistance please contact me at (804)444-8416 or Peter Yost at (215)441-3094.

Sincerest Regards,



Michael E. Brock
Aerospace Engineer

NOTE

**THERE ARE NO PROVISIONS FOR
MANUAL BAILOUT IN THE EVENT
OF EJECTION SEAT FAILURE**

SEQUENCING TIMES INDICATED ARE AFTER CATAPULT FIRING (INITIAL SEAT MOVEMENT). TO DETERMINE TOTAL TIME, A TIME FACTOR FOR THE PERIOD BETWEEN PULLING THE EJECTION CONTROL HANDLE AND CATAPULT FIRING MUST BE ADDED TO THE FIGURES SHOWN. THIS TIME INTERVAL REPRESENTS THE TIME IT TAKES FOR CANOPY JETTISON AND IS APPROXIMATELY 0.30 SECONDS AT ZERO AIRSPEED. THERE IS AN ADDITIONAL 0.40 SECOND DELAY BETWEEN THE REAR COCKPIT SEAT AND THE COCKPIT SEAT IN F/A-18B AND F/A-18D.



1840-120-10-(27-1)10-SCAN

WARNING

MINIMUM ALTITUDES ARE DEPENDENT UPON DIVE ANGLE, AIRSPEED AND BANK ANGLE. RECOMMENDED MINIMUMS ARE 10,000 FEET (AGL) IF OUT OF CONTROLLED FLIGHT AND 2,000 FEET (AGL) IN CONTROLLED FLIGHT.

THE EJECTION SEQUENCE STARTS WHEN THE EJECTION CONTROL HANDLE IS PULLED UPWARD.

- A** IFF SWITCH ACTUATED, PIN PULLER POSITIONED, INERTIA REEL POSITIONS CREWMEMBER, CANOPY IS JETTISONED.
- B** CATAPULT IS FIRED (INITIAL SEAT MOVEMENT) CREWMEMBERS LEGS ARE RESTRAINED, EMERGENCY OXYGEN IS ACTIVATED, ELECTRICAL POWER IS DISCONNECTED, PERSONAL SERVICES (OXYGEN AND COMMUNICATIONS) BETWEEN-SEAT AND AIRCRAFT ARE DISCONNECTED. DROGUE GUN AND TIME RELEASE MECHANISM TRIP RODS ARE TRIPPED. THE ROCKET MOTOR IS FIRED ON COMPLETION OF FULL CATAPULT EXTENSION (APPROX. 76 INCHES).
- C** DROGUE GUN FIRES, CONTROLLER (PILOT) DROGUE AND STABILIZER DROGUE ARE DEPLOYED TO STABILIZE AND DECELERATE THE SEAT.

Figure 6. Ejection Seat System Sequencing Schematic (Sheet 1)

D ON HIGH ALTITUDE SEQUENCE - AT ALTITUDES ABOVE 13,000 ± 1500 FEET AN ALTITUDE SENSING BAROSTAT (INTERNAL TIME RELEASE MECHANISM) PREVENTS PREMATURE DEPLOYMENT OF PERSONNEL PARACHUTE AND ALLOWS CREWMEMBER TO MAKE A RAPID DESCENT TO A SAFE ALTITUDE.

NOTE

IF EMERGENCY OXYGEN FAILS TO RELEASE AUTOMATICALLY UPON EJECTION, PULL THE MANUAL OXYGEN RELEASE RING (GREEN RING) STOWED ON LEFT SIDE OF SURVIVAL KIT (INBD) UNDERNEATH CUSHION.

E AT ALTITUDES ABOVE 7,000 TO 8,000 FEET, THE TIME DELAY (FOR PERSONNEL PARACHUTE DEPLOYMENT) IS CONTROLLED BY A G-CONTROLLER (INTERNAL TIME RELEASE MECHANISM) WHICH INTERRUPTS THE TIMING SEQUENCE UNTIL DECELERATION FORCE IS LESS THAN 3 G'S. AT ALTITUDES BELOW 7,000 TO 8,000 FEET, THE TIME DELAY MECHANISM (1.50 SECONDS) STARTS WITHOUT INTERRUPTION. AFTER THE 1.50 SECOND DELAY, THE TIME RELEASE MECHANISM CARTRIDGE FIRES, RELEASING THE UPPER AND LOWER RESTRAINT MECHANISMS PARACHUTE MECHANICAL LOCK AND DROGUE SHACKLE FROM SCISSOR MECHANISM.

F AT FULL DEVELOPMENT (OPENING SHOCK) OF PERSONNEL PARACHUTE, THE CREWMEMBER AND SURVIVAL KIT SEPARATE FROM THE SEAT (HELD IN ONLY BY STICKER CLIPS). RADIO BEACON IS ACTIVATED AT CREWMEMBER/SEAT SEPARATION.

G NORMAL PARACHUTE DESCENT.

H SURVIVAL KIT DEVELOPEMENT - WHILE DESCENDING, CREWMEMBER (OPTION) MAY ACTIVATE SURVIVAL KIT HANDLE AND OPEN KIT FOR DEPLOYMENT OF SURVIVAL EQUIPMENT LIFE RAFT.

J AFTER ACC 446, FOLLOWING DESCENT AND LANDING IN SEA WATER, SEWARS IS ACTIVATED RELEASING CREWMEMBER FROM PERSONNEL PARACHUTE.

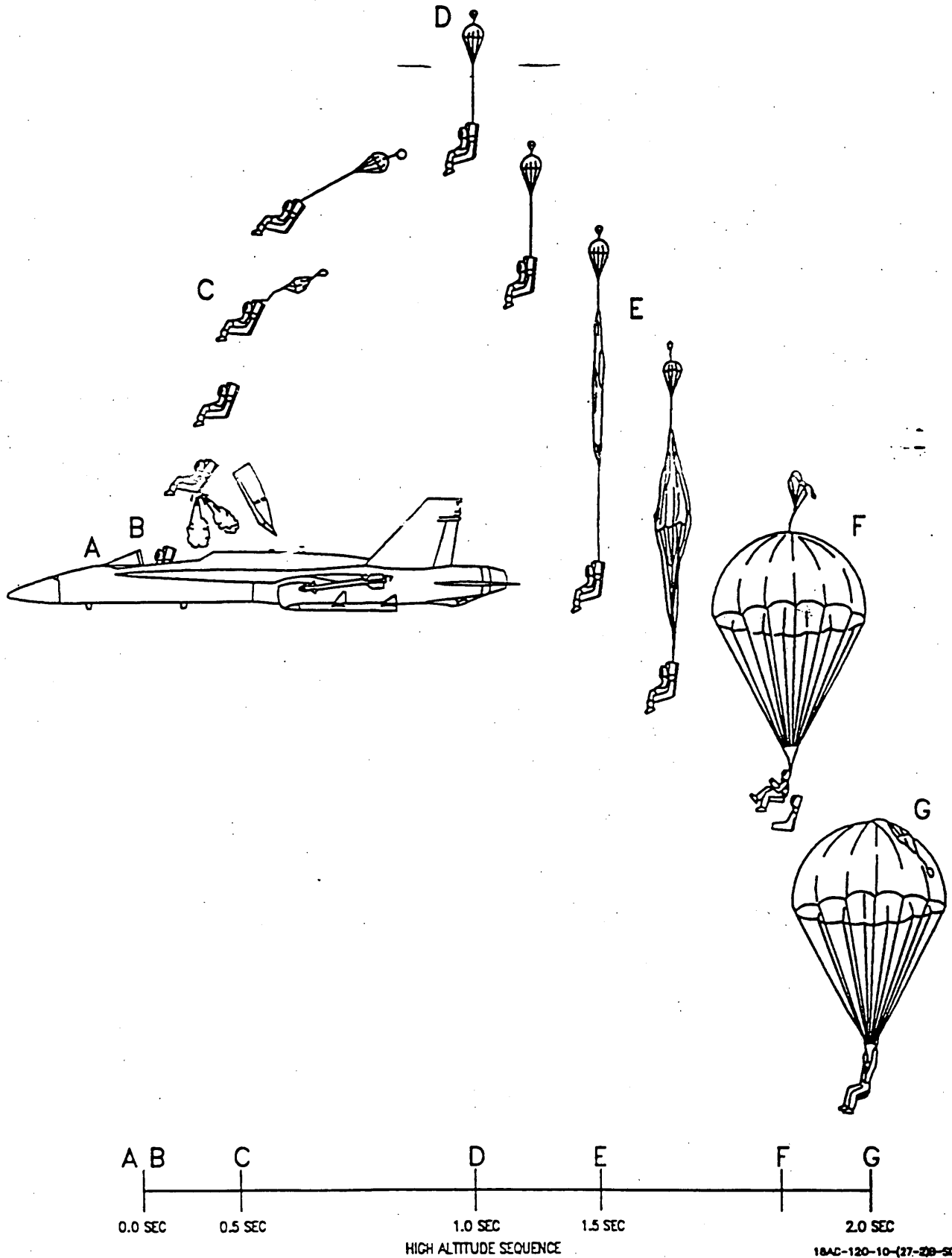
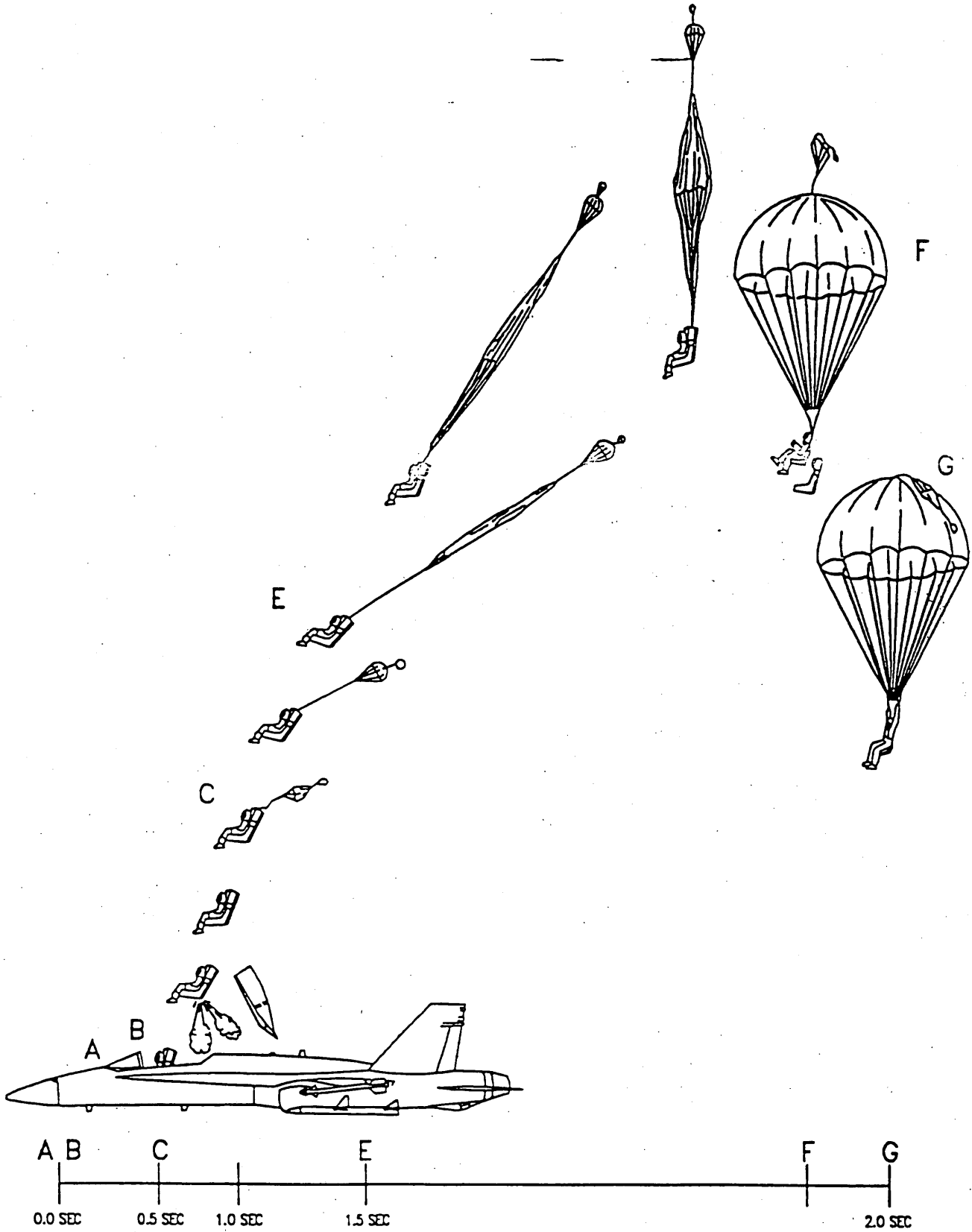

Figure 6. Ejection Seat System Sequencing Schematic (Sheet 3)



LOW ALTITUDE SEQUENCE

10AC-120-10-(27-3)B-SCAN

Figure 6. Ejection Seat System Sequencing Schematic (Sheet 4)

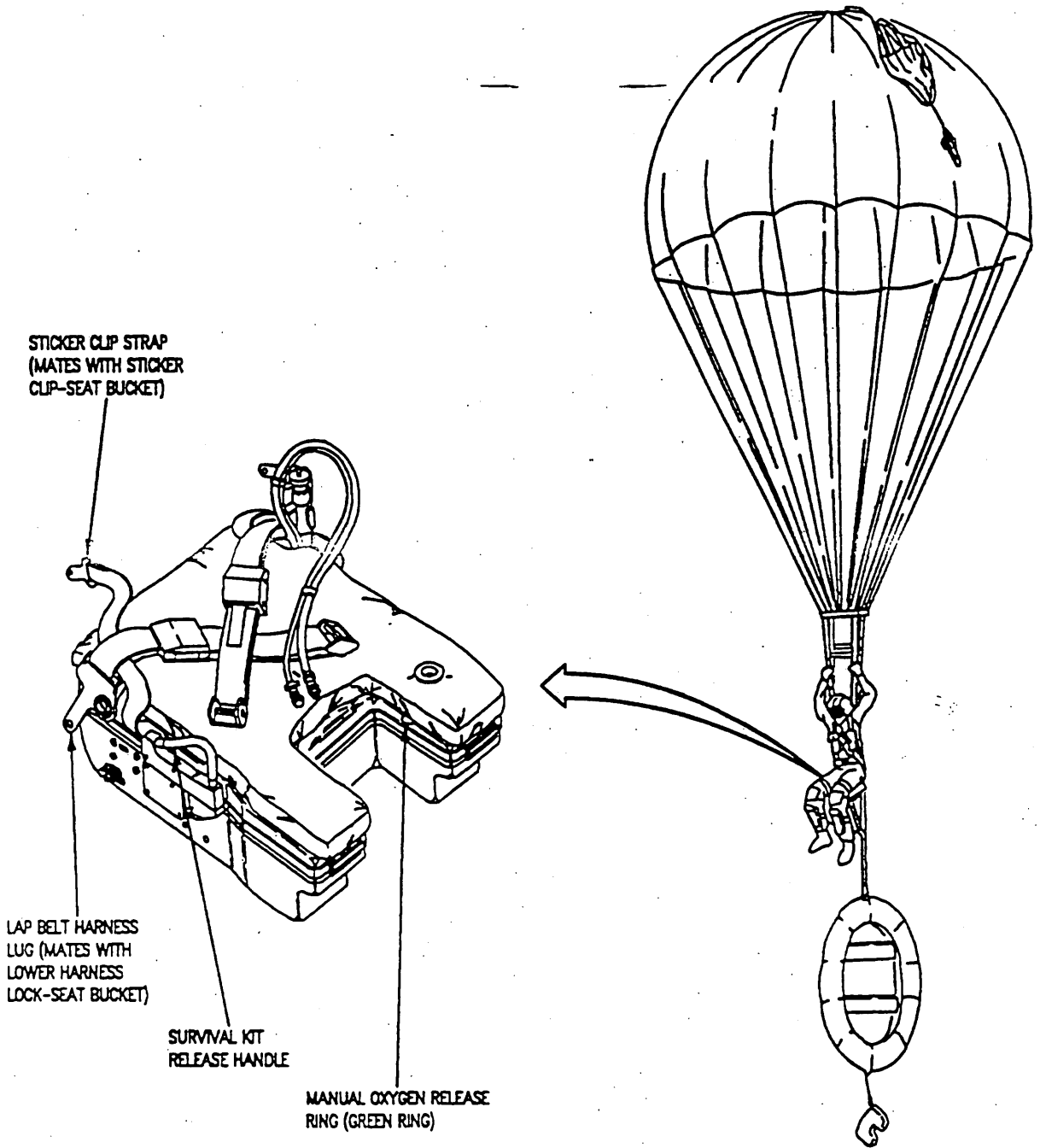

H

LIFE RAFT INFLATION IS INITIATED BY GRAVITY WHEN THE DROP LINE IS FULLY EXTENDED AFTER SURVIVAL KIT OPENING.

WARNING

IF THE SURVIVAL KIT IS DEPLOYED AFTER LANDING IN WATER, A SNATCH PULL ON THE DROP LINE (NEAR CO₂ BOTTLE) IS REQUIRED TO INFLATE THE LIFE RAFT.

Figure 6. Ejection Seat System Sequencing Schematic (Sheet 5)

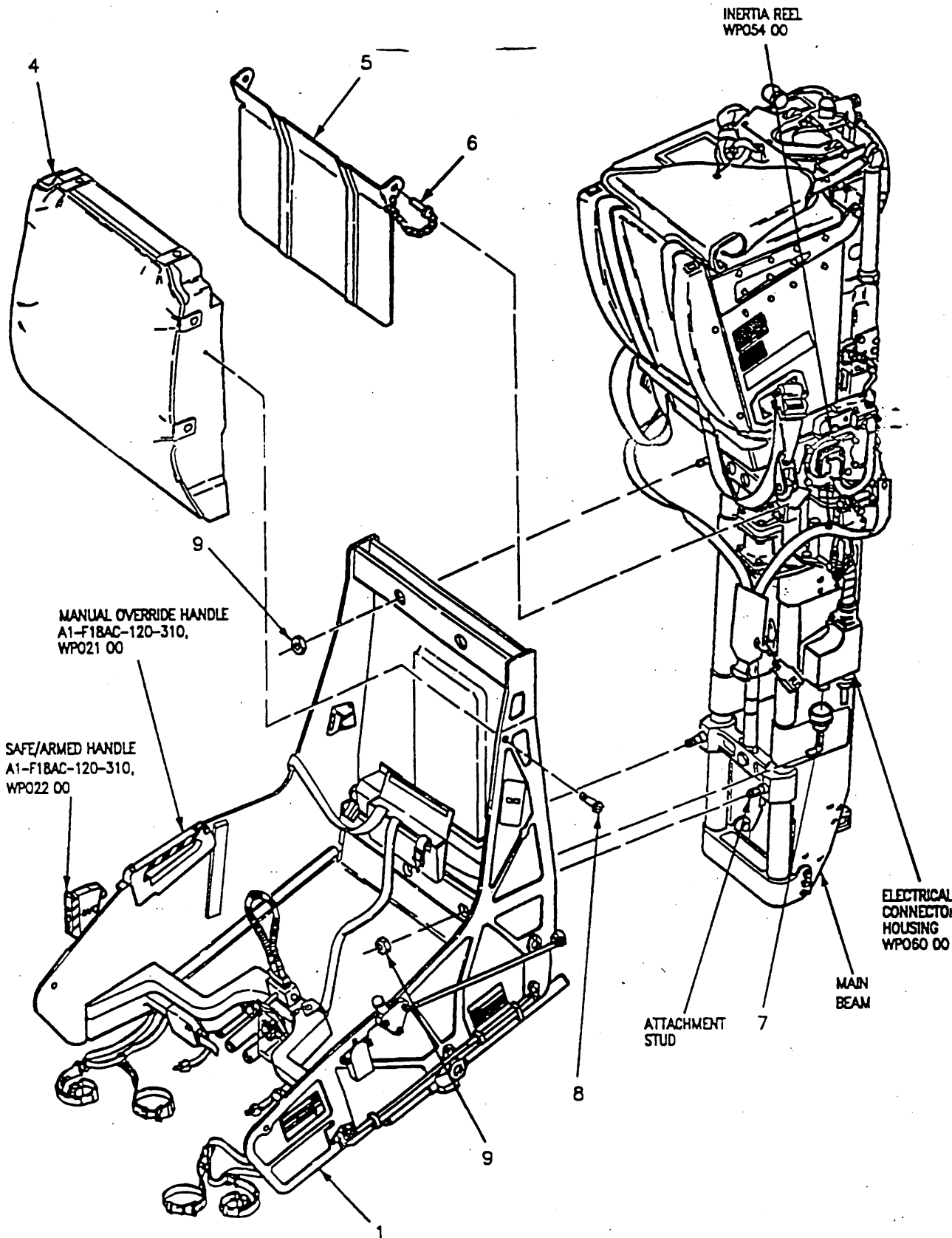

Figure 1. Seat Bucket (25MAH558 or 25MAK559) Removal and Installation (Sheet 2)

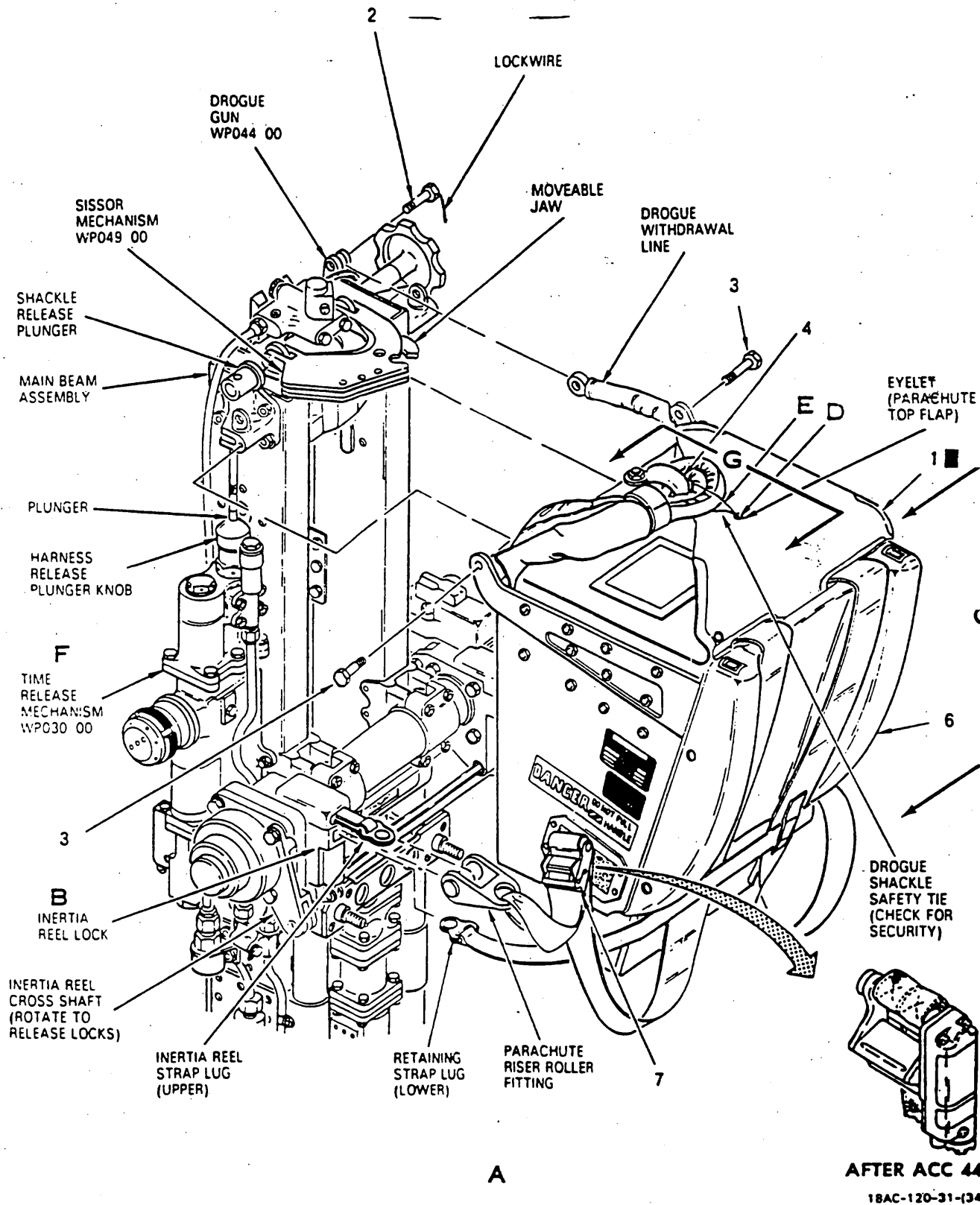

Figure 1. Aircraft Seat Parachute A/P28S-24 (25MAH578 or 25MAK579)- Removal and Installation (Sheet 2)

31. SYSTEM OPERATION.

32. The SAFE/ARMED handle (WP005 03 and WP005 04) is set to the ARMED position (seat-armed) when the aircraft is ready for flight. When in the ARMED position, the visible portion of the handle is colored with yellow and black markings and placarded as ARMED. When in the SAFE position, the visible portion is colored white and placarded as SAFE.

The emergency escape sequencing system provides for canopy jettison and ejection of seats in correct sequence. The selection of sequencing is made on the ejection selector in the rear cockpit. There are three selections:

a. Normal - When sequence is initiated from the cockpit, both seats are ejected with the rear seat first. When sequence is initiated from the rear cockpit only the rear seat is ejected.

b. Solo - Selection is used when the rear cockpit is not used.

c. Aft - Both seats are ejected with the rear seat first when initiated from cockpit or rear cockpit.

The ejection sequence starts when the ejection control handle is pulled. Upward movement of the ejection control handle removes two sears from the seat initiator, firing two cartridges within the seat initiator.

33. FIRING SEQUENCE. Ejection seat firing sequence (WP005 03) is operated by ballistic gas pressure and SMDC explosive stimulus traveling through the system. Ballistic gas pressure produced by the right cartridge in the ejection seat initiator 25GPJ501 is routed through the system in the sequence listed below:

a. Actuates the pin puller 25GPJ532.

b. Fires the inertia reel 25GPH503 cartridge.

c. Fires the gas to SMDC initiator 25GPJ505 which:

(1) Fires the canopy jettison system (WP006 00) by way of the one-way transfer valve 20GPK530.

(2) Activates the IFF switch 78S-K005 (A1-F18AC-600-100, WP023 00 and WP024 00).

—d. Fires the 0.30 second delay initiator 25GPJ529.

34. Ballistic gas pressure produced by the left cartridge in the ejection seat initiator 25GPH501 is routed through the system in the sequence listed below:

a. Fires the 0.30 second delay initiator 25GPH530.

b. Ballistic gas pressure from either or both 0.30 second delay initiators 25GPJ529 and 25GPJ530 fires the primary cartridge in the catapult 25GPH508 by way of the manifold check valve 25GPH507.

c. For CATAPULT FIRING AND INITIAL SEAT MOVEMENT, go to paragraph 45.

35. COCKPIT INITIATED FIRING SEQUENCE (NORMAL Selection). Ejection seat firing sequence (WP005 04) is operated by ballistic gas pressure and SMDC explosive stimulus traveling through the system. Ballistic gas pressure produced by the right cartridge in the cockpit ejection seat initiator 25GPJ501 is routed through the system in the sequence listed below:

a. Activates the cockpit ejection seat pin puller 25GPJ532.

b. Fires the cockpit ejection seat inertia reel 25GPH503 cartridge.

c. Fires the cockpit gas to SMDC initiator 25GPJ505, which:

(1) Arms the sequencer 25GPK527.

(2) Fires the canopy jettison system (WP007 00), by way of the ejection selector 25MAL521 (INPUT to NORM) and one-way transfer valves 25GPL523 and 25GPL524.

(3) Fires the 0.40 second delay initiator 25GPK528.

(4) Fires the rear cockpit SMDC to gas initiator 25GPK517.

(5) Activates the rear cockpit ejection seat pin puller 25GPL533.

(6) Fires the rear cockpit ejection seat inertia reel 25GPK514 cartridge.

(7) Fires the rear cockpit ejection seat 0.30 second delay initiator 25GPL518.

(8) Fires the primary cartridge in the rear cockpit ejection seat catapult 25GPK520 by way of the rear cockpit ejection seat manifold check valve 25GPK519.

d. At this point in the firing sequence, only the rear cockpit ejection seat catapult has fired. For CATAPULT FIRING AND INITIAL SEAT MOVEMENT, go to paragraph 45. For continuation of dual ejection sequence, go to step e.

e. Explosive stimulus from the 0.40 second delay initiator 25GPK528 fires the 0.30 second delay initiator 25GPK526, which by way of the sequencer 25GPK527:

(1) Activates the IFF switch 78S-L005 (A1-F18AC-600-100, WP023 00 and WP024 00).

(2) Fires the cockpit SMDC to gas initiator 25GPH511.

36. Ballistic gas pressure produced by the left cartridge in the cockpit ejection seat initiator 25GPJ501 is routed through the system in the sequence listed below:

a. Fires the 0.75 second delay initiator 25GPH510.

b. Ballistic gas pressure from either or both the 0.75 second delay initiator 25GPH510 or the SMDC to gas initiator 25GPH511 fires the primary cartridge in the cockpit ejection seat catapult 25GPH508, by way of the cockpit ejection seat manifold check valve 25GPH507.

c. At this point in the firing sequence both catapults have fired. For CATAPULT FIRING AND INITIAL SEAT MOVEMENT, go to paragraph 45.

37. REAR COCKPIT INITIATED FIRING SEQUENCE (NORMAL Selection). Rear cockpit ejection seat firing sequence (WP005 04) is operated by ballistic

gas pressure and SMDC explosive stimulus traveling through the system. Ballistic gas pressure produced by the right cartridge in the rear cockpit ejection seat initiator 25GPL512 is routed through the system in the sequence listed below:

a. Actuates the rear cockpit ejection seat pin puller 25GPL533.

b. Fires the rear cockpit ejection seat inertia reel 25GPK514 cartridge.

c. Fires the 0.30 second delay initiator 25GPL518.

d. Fires the rear cockpit gas to SMDC initiator 25GPL516, which:

(1) Fires the canopy jettison system (WP007 00), by way of the one-way transfer valve 25GPL524.

(2) Fires the 0.40 second delay initiator 25GPK528.

(3) Fires the 0.30 second delay initiator 25GPK526.

e. At this point in the firing sequence, explosive stimulus stops at the sequencer 25GPK527, preventing activation of the IFF switch 78S-L005 and initiation of the cockpit ejection seat. For continuation of the firing sequence, go to paragraph 38.

38. Ballistic gas pressure produced by the left cartridge in the rear cockpit ejection seat initiator 25GPL512 is routed through the system in the sequence listed below:

a. Fires the 0.30 second delay initiator 25GPK522.

b. Ballistic gas pressure from either or both 0.30 second delay initiators 25GPL518 and 25GPK522 fires the primary cartridge in the rear cockpit ejection seat catapult 25GPK520, by way of the rear cockpit ejection seat manifold check valve 25GPK519.

c. At this point in the firing sequence, only the rear cockpit ejection seat catapult has fired. The cockpit ejection seat and IFF switch activation must be initiated from the cockpit.

d. For CATAPULT FIRING AND INITIAL SEAT MOVEMENT, go to paragraph 45.

39. COCKPIT INITIATED FIRING SEQUENCE (SOLO Selection). Ejection seat firing sequence (WP005 04) is operated by ballistic gas pressure and SMDC explosive stimulus traveling through the system. Ballistic gas pressure produced by the right cartridge in the cockpit ejection seat initiator 25GPJ501 is routed through the system in the sequence listed below:

a. Activates the cockpit ejection seat pin puller 25GPJ532.

b. Fires the cockpit ejection seat inertia reel 25GPH503 cartridge.

c. Fires the gas to SMDC initiator 25GPJ505, which:

(1) Arms the sequencer 25GPK527.

(2) Fires the canopy jettison system (WP007 00), by way of the ejection selector 25MAL521 (INPUT to SOLO), and the one-way transfer valve 25GPK525.

(3) Fires the 0.30 second delay initiator 25GPK526.

(4) Activates the IFF switch 78S-L005 (A1-F18AC-600-100, WP023 00 and WP024 00), by way of the sequencer 25GPK527.

(5) Fires the SMDC to gas initiator 25GPH511.

d. At this point in the firing sequence, explosive stimulus is prevented from initiating the rear cockpit ejection seat by the ejection selector 25MAL521 and the one-way transfer valve 25GPL524. For continuation of the firing sequence, go to paragraph 40.

40. Ballistic gas pressure produced by the left cartridge in the cockpit ejection seat initiator

-25GPJ501 is routed through the system in the sequence listed below:

a. Fires the 0.75 second delay initiator 25GPH510.

b. Ballistic gas pressure from either or both the 0.75 second delay initiator 25GPH510 or the SMDC to gas initiator 25GPH511 fires the primary cartridge in the cockpit ejection seat catapult 25GPH508, by way of the cockpit ejection seat manifold check valve 25GPH507.

c. At this point in the firing sequence, only the cockpit catapult has fired and the IFF switch is activated. The rear cockpit ejection seat remains in the aircraft.

d. For CATAPULT FIRING AND INITIAL SEAT MOVEMENT, go to paragraph 45.

41. COCKPIT INITIATED FIRING SEQUENCE (AFT Initiate Selection). Ejection seat firing sequence (WP005 04) is operated by ballistic gas pressure and SMDC explosive stimulus traveling through the system. Ballistic gas pressure produced by the right cartridge in the cockpit ejection seat initiator 25GPJ501 is routed through the system in the sequence listed below:

a. Actuates the cockpit ejection seat pin puller 25GPJ532.

b. Fires the cockpit ejection seat inertia reel 25GPH503 cartridge.

c. Fires the cockpit gas to SMDC initiator 25GPJ505, which:

(1) Arms the sequencer 25GPK527.

(2) Fires the canopy jettison system (WP007 00), by way of the ejection selector 25MAL521 (INPUT to AFT INITIATE) and the one-way transfer valve 25GPL524.

(3) Fires the 0.40 second delay initiator 25GPK528.

(4) Fires the rear cockpit SMDC to gas initiator 25GPL517.

(5) Actuates the rear cockpit ejection seat pin puller 25GPL533.

(6) Fires the rear cockpit ejection seat inertia reel 25GPK514 cartridge.

(7) Fires the rear cockpit ejection seat 0.30 second delay initiator 25GPL518.

(8) Fires the primary cartridge in the rear cockpit ejection seat catapult 25GPK520, by way of the rear cockpit ejection seat manifold check valve 25GPK519.

d. At this point in the firing sequence, only the rear cockpit ejection seat catapult has fired. For CATAPULT FIRING AND INITIAL SEAT MOVEMENT, go to paragraph 45. For continuation of dual ejection sequence, go to step e.

e. Explosive stimulus from the 0.40 second delay initiator 25GPK528 fires the 0.30 second delay initiator 25GPK526, which, by way of the sequencer 25GPK527, initiates the following:

(1) Activates the IFF switch 78S-L005 (A1-F18AC-600-100, WP023 00 and WP024 00).

(2) Fires the cockpit SMDC to gas initiator 25GPH511.

42. Ballistic gas pressure produced by the left cartridge in the cockpit ejection seat initiator 25GPJ501 is routed through the system in the sequence listed below:

a. Fires the 0.75 second delay initiator 25GPH510.

b. Ballistic gas pressure from either or both the 0.75 second delay initiator 25GPH510 or the SMDC to gas initiator 25GPH511, fires the primary cartridge in the cockpit ejection seat catapult 25GPH508, by way of the cockpit ejection seat manifold check valve 25GPH507.

c. At this point in the firing sequence, both catapults have fired. For CATAPULT FIRING AND INITIAL SEAT MOVEMENT, go to paragraph 45.

43. REAR COCKPIT INITIATED FIRING SEQUENCE (AFT Initiate Selection). Ejection seat firing sequence (WP005 04) is operated by ballistic gas

pressure and SMDC explosive stimulus traveling through the system. Ballistic gas pressure produced by the right cartridge in the rear cockpit ejection seat initiator 25GPL512 is routed through the system in the sequence listed below:

a. Actuates the rear cockpit ejection seat pin puller 25GPL533.

b. Fires the rear cockpit ejection seat inertia reel 25GPK514 cartridge.

c. Fires the 0.30 second delay initiator 25GPL518.

d. Fires the rear cockpit gas to SMDC initiator 25GPL516, which:

(1) Fires the canopy jettison system (WP007 00), by way of the one-way transfer valve 25GPL524.

(2) Fires the 0.40 second delay initiator 25GPK528.

(3) Arms the sequencer 25GPK527 (INPUT A), by way of the ejection selector 25MAL521 (AFT INITIATE to INPUT).

(4) Fires the cockpit SMDC to gas initiator 25GPJ506, which:

(a) Actuates the cockpit ejection seat pin puller 25GPJ532.

(b) Fires the cockpit ejection seat inertia reel 25GPH503 cartridge.

44. Ballistic gas pressure produced by the left cartridge in the rear cockpit ejection seat initiator 25GPL512 is routed through the system in the sequence listed below:

a. Fires the rear cockpit ejection seat 0.30 second delay initiator 25GPK522.

b. Ballistic gas pressure from either or both rear cockpit ejection seat 0.30 second delay initiators 25GPL518 and 25GPK522 fires the primary cartridge in the rear cockpit ejection

seat catapult 25GPK520, by way of the rear cockpit ejection seat manifold check valve 25GPK519.

c. At this point in the firing sequence, only the rear cockpit ejection seat catapult has fired. For CATAPULT FIRING AND INITIAL SEAT MOVEMENT, go to paragraph 45. For continuation of dual ejection sequence, go to step d.

d. Explosive stimulus from the 0.40 second delay initiator 25GPK528 is routed through the system in the sequence listed below:

(1) Fires the 0.30 second delay initiator 25GPK526.

(2) Explosive stimulus travels across the sequencer 25GPK527, (INPUT B to OUTPUT B).

(3) Activates the IFF switch 78S-L005 (A1-F18AC-600-100, WP023 00 and WP024 00).

(4) Fires the cockpit SMDC to gas initiator 25GPH511.

(5) Fires the primary cartridge in the cockpit ejection seat catapult 25GPH508, by way of the cockpit ejection seat manifold check valve 25GPH507.

e. At this point in the firing sequence, both catapults have fired. For CATAPULT FIRING AND INITIAL SEAT MOVEMENT, go to paragraph 45.

45. CATAPULT FIRING AND INITIAL SEAT MOVEMENT.

46. Ballistic gas pressure produced by the catapult primary cartridge causes the inner and intermediate pistons within the catapult to rise (seat attached), releasing the top latch mechanism (initial seat movement). The secondary cartridges within the catapult fire progressively as the rising pistons are exposed to the heat and pressure of the primary cartridge gas. Progressive firing of the catapult secondary cartridges provide a relatively even gas pressure during catapult extension to prevent excessive G-force build up during ejection.

47. As the seat moves upward:

a. The emergency oxygen system is activated.

b. A trip rod withdraws the firing link from the drogue gun starting a 0.50 internal timer.

c. A trip rod withdraws the firing link from the time release mechanism.

d. Aircraft electrical power is disconnected.

e. Personal services (oxygen and communication) between seat and aircraft are disconnected.

f. The leg restraint lines are drawn through the snubbing units and restrain the crewmembers legs to the seat bucket. When the leg restraint lines become taut, the upper portion of the leg restraint line shears (by way of a shear ring) from the tower portion attached to the floor bracket. Forward movement of the lines is prevented by the snubbing units.

g. After 72 inches of catapult extension, the rocket motor initiator is fired by a cable attached to the drogue gun trip rod. Ballistic gas pressure produced by the cartridge within the rocket motor initiator is routed to a pressure actuated firing mechanism located on the rocket motor. The firing mechanism fires the rocket motor. Flame and pressure ignite the rocket motor propellant grain. The thrust of the rocket motor is approximately 4500 pounds for 0.25 seconds.

48. SEAT SEPARATION FROM AIRCRAFT.

49. At 76 inches of catapult extension, the catapult inner piston separates from the intermediate piston. The seat is now clear of aircraft.

50. The nozzles on one side of the rocket motor have a larger port than on the opposite side. On single seat configuration, the nozzle configuration causes an angular trajectory to the left of the aircraft. On dual seat configuration, the cockpit seat trajectory is to the right and rear cockpit seat trajectory is to the left. On dual seat configuration, the rear seat will leave the aircraft first.

51. The drogue gun primary cartridge fires after a 0.50 second delay, propelling the piston from the drogue gun barrel. The inertia of the piston extracts the parachute flap closure pin and deploys the 22 inch controller drogue which deploys the 60 inch stabilization and retardation drogue. The 0.50 second time delay allows maximum altitude to be reached by the time the drogues are fully developed. The seat is stabilized and decelerated by the drogues, which are held to the seat by the scissor mechanism.

52. If the drogue gun primary cartridge fails to fire, ballistic gas pressure will pass to the drogue gun when the time release mechanism fires. This gas drives a firing pin forward, shearing its retaining pin, and the secondary drogue gun cartridge is fired resulting in drogue deployment. Should both the drogue gun primary and time release mechanism cartridges fail to fire, operation of the MANUAL OVERRIDE HANDLE will fire the manual override initiator cartridge, copying the function of the TRM and firing the drogue gun secondary cartridge.

53. An internal altitude sensing barostat prevents the time delay mechanism from starting at altitudes above $13,000 \pm 1,500$ feet. The barostat makes sure the crewmember is brought rapidly, but controlled, down through the upper atmosphere following an ejection at high altitude. At altitudes above 7,000 to 8,500 feet the time delay for deployment of the personnel parachute is controlled by an internal G-controller which interrupts the timing sequence until deceleration force is less than 3G's. This results in lower parachute opening loads in this altitude range. At altitudes below 7,000 to 8,500 feet, the time delay mechanism (1.50 second) starts without interruption. After the 1.50 second time delay, the time release mechanism cartridge fires releasing.

a. Upper restraint mechanism.

b. Lower restraint mechanism.

c. Parachute mechanical lock.

d. Drogue shackle from the scissor mechanism.

54. The drogues (now free from the scissor mechanism) deploy the personnel parachute. The personnel parachute, when fully developed, lifts the crewmember and the survival kit from the seat pulling the sticker clip strap lugs from their clips. This makes sure there is no possibility of collision between seat and crewmember after separation. The radio beacon activates at crewmember/seat separation and a normal parachute descent follows.

55. While descending in the parachute, the crewmember can actuate the survival kit handle (located on the rear right side) to open the kit halves, which allows deployment and automatic inflation of the life raft. The life raft and survival kit items (held within an equipment bag) are connected by a lanyard to the survival kit lid, attached to the crewmember.

56. On ejection seats after ACC 446, an automatic backup method of releasing the parachute canopy when landing in sea water following an emergency ejection is installed. Sea Water Activated Release System (SEAWARS) is made up of two releases mounted outboard of the quick release fittings connected on the parachute risers. Each release has an electronics package (sensor), battery, cartridge and canopy release fitting. Submersion in sea water activates the sensors, which mechanically release the parachute risers from the crewmember's torso harness. With SEAWARS installed, the normal procedures for connecting and releasing the quick release fittings are the same.

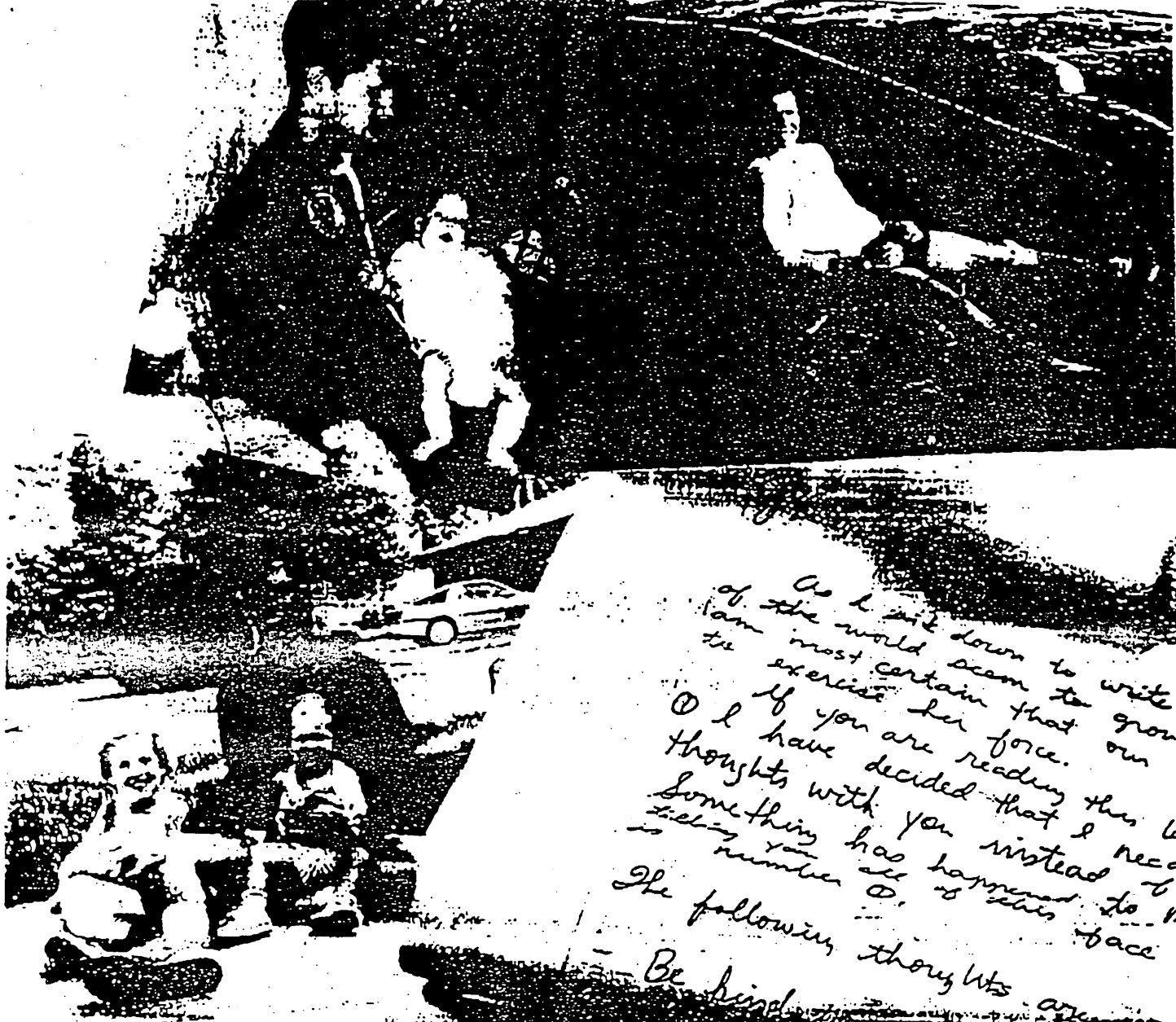

As I sit down to write
of the world seem to grow
I am most certain that you
to exercise her force.
If you are reading this
I have decided that I need
thoughts with you instead of
something has happened to
telling you all is this
number 0, is this face
The following thoughts are

Be kind
Spike

AN AMERICAN HERO: SCOTT WAS
A PATRIOT WHO LOVED TO
FLY. BUT HE DEEPLY LOVED HIS
FAMILY, TOO. WHETHER
RELAXING WHILE OFF-DUTY
ON THE SARATOGA
(TOP RIGHT) OR WRITING
A LAST LETTER (CENTER),
HIS THOUGHTS WERE
ALWAYS WITH THEM

THE WINGS OF LOVE

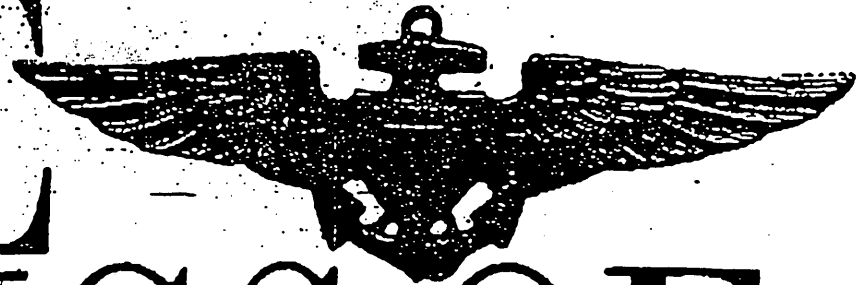

LIKE MANY ANOTHER PILOT'S WIFE, JO-ANNE SPEICHER WAS TERRIFIED THAT HER HUSBAND WOULD DIE IN THE SKIES OVER THE GULF. BUT SHE BRUSHED ASIDE HER FEARS—UNTIL SHE HEARD THE TERRIBLE NEWS. HERE, THE MOVING STORY OF THE FIRST CASUALTY IN OPERATION DESERT STORM.

BY KATHRYN CASEY

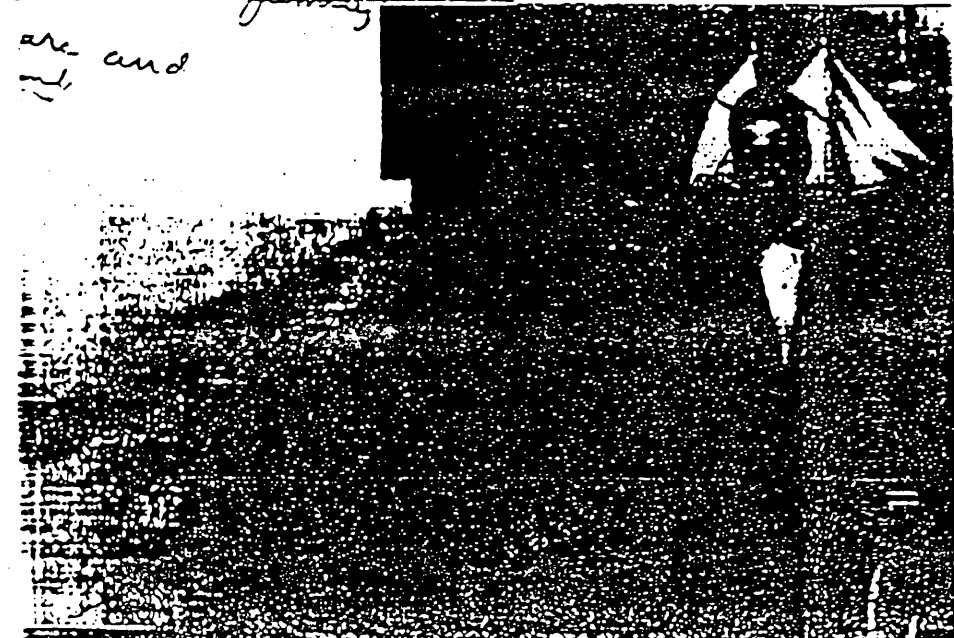

JoAnne Speicher holds in her hands a thick brown envelope that still smells somewhat faintly of both sea air and jet fuel. "It's the way he used to smell when he came home," she says, taking a deep breath.

Inside the envelope are the personal effects of her husband, Scott, the first casualty of Operation Desert Storm: a red nylon wallet with his driver's license, credit card and pictures of their children, Meghan, four, and Michael, two; a slender gold wedding band; and a pair of gold aviator's wings.

"I think maybe Scott knew... like I did," JoAnne says, running her fingers gently over (continued on page 197)

The day was Heaven Sent...
so was her fragrance.

Some moments
are simply

Heaven Sent
Fragrance Essentials

WINGS OF LOVE

continued

she might have upset him, and she quickly wrote him a reassuring letter.

Nothing happened during the day of January 15, but that night, after JoAnne turned on CNN, she—like much of America—learned that the air war had begun.

"I knew right away that Scott would be in the first strike," she says proudly. "He was so good." Her fear gave way to excitement as she stayed up until midnight watching events unfold. And when another Navy wife called, looking frantically for hope, JoAnne told her. "Our guys are going to be home soon. I promise."

Her euphoria didn't last long. The next morning, JoAnne heard a TV reporter talking about a downed F-18. Though she was momentarily shaken, she reassured herself that if it had been Scott's plane, she would have been told. On TV, JoAnne recalls, the reporting became more frenzied as the morning wore on. At first the F-18 was referred to as a Navy plane. Minutes later, a television correspondent referred to it as a Marine jet.

"I told myself that no news was good news," JoAnne says. "I called the other wives in Scott's squadron, and my mother and sisters, and said, 'Don't worry.'"

But as JoAnne talked on the phone that afternoon, she heard a car door close. She looked out the screen door toward the driveway and saw the admiral of Cecil Field, the local base, the commodore, the commodore's wife and the chaplain. The men were in their dress blues.

"They didn't have to say a thing," JoAnne recalls, her eyes filling with tears. "The first thing I asked was, 'How did it happen?'"

Scott's last hours

For JoAnne, the first few days following the news about her husband are a blur. As she had suspected, Scott, the first casualty of the war, had been in the conflict's first air strike. Sometime after the bombing began, another fighter pilot reported seeing an explosion in western Iraq near the targets Scott had been assigned to bomb. The commodore at Cecil Field later said that it was probably Scott's plane being hit by a surface-to-air missile.

Technically, Scott was listed as missing in action. But although the military couldn't rule out the possibility that he had somehow miraculously survived, there had been no radio contact, and authorities held out virtually no hope.

Word spread quickly that Scott was the downed F-18 pilot, and the Speichers' house began filling with family and friends. One woman, who had lost her first husband in a crash seven years earlier, staffed the phone, taking calls from reporters and sympathizers. JoAnne sat on the couch, somewhat dazed, and talked with her visitors. Later, they would tell her that she had taken the news well.

In the midst of her grief, and the near-chaos in her house, JoAnne thought of her children. Michael played on obliviously, but JoAnne knew she had to talk to Meghan.

In her daughter's cheerful bedroom, JoAnne asked Meghan if she understood why the house was filled with people. "No," the little girl replied. "It's because they have to tell me about Daddy," JoAnne said gently. "Something happened to Daddy's airplane." Meghan sat quietly considering her mother's words before venturing, "My daddy?"

"Yup," JoAnne replied.

"I didn't want him to be scared"

JoAnne slept uneasily that night. In the back of her mind were some heartbreaking questions: What were Scott's final moments like? Did he know he was going to die? The next morning, determined not to break the routine she had estab-

WINGS OF LOVE

continued from page 135

the wings, which she gave him last July, when he made lieutenant commander on his thirty-second birthday.

The Speichers' battleship-gray ranch house, in Jacksonville, Florida, is filled with mementos of Scott's life. Books on flying fill the living-room shelves, and pictures of the sleek planes he flew cover the walls. In the VCR, there's a video of Scott splashing in the backyard pool, blowing bubbles with his two young children.

"We made it last summer, before he shipped out," says JoAnne, thirty-two, a slender woman with a crown of brown curls. "He was worried that Michael was so small he would forget him."

What Scott Speicher loved most in the world, next to his family, was flying—the rush of adrenaline when he piloted his F-18 Hornet toward the end of the runway on the massive aircraft carrier *Saratoga*.

Flying hadn't always been part of Scott's career plan; when he met JoAnne, a marketing student, at Florida State University in 1977, he was a business major, one year ahead of her. But after his first job interview, he told JoAnne that a nine-to-five office job wasn't for him.

"I can't sit behind a desk every day," he told her. "I want to fly." Scott had never piloted a plane, but since childhood, he'd heard stories from his father, a World War II fighter pilot.

"I was behind him all the way," JoAnne says. "I said, 'Go for it.'"

One month after graduation, he was in naval officers' training school in Pensacola, Florida. From the beginning he was an excellent pilot, and over the years his superiors singled him out as an exceptional achiever.

JoAnne and Scott married two and a half years after he entered the military—long enough for him to finish training and for her to work for a while as an assistant department-store buyer. Despite the couple's happiness, death was always a presence; just four days before their Navy wedding at Cecil Field in December 1983, a close friend died flying maneuvers over Ocala National Forest.

Scott, mindful of the danger he faced, habitually made sure his affairs were in order before leaving on deployments, which could last several months.

"If anything happens to me, you know what to do?" he'd quiz JoAnne. "Yes," she'd answer. "I hated to get into it," she says now, sighing. "But it was always in the back of your mind."

Her fears seemed more frighteningly plausible than ever after Iraq invaded Kuwait last August, and the *Saratoga* received orders to head for the Persian

Anne's Honey Mustard Masterpieces

Pour prepared Good Seasons® Honey Mustard Dressing over chicken parts. Marinate in refrigerator at least 3 hours. Cook as desired.

You Make It Fresh. You Make It Best.™



Gulf. Watching the news together one night before the carrier left, JoAnne shuddered slightly and said to her husband, "Oh, God, I hope we don't have to go to war."

Scott, reluctant to leave his family yet exhilarated at the prospect of putting into action everything he had practiced for the past decade, turned to her and said, "How could you say that? That's my job."

An ordinary good-bye

August 7, the morning Scott went off to war, was like any other in the Speicher household. JoAnne kissed him good-bye at the front door, Michael and Meghan waved as he drove away. "This was a part of our lives," she says. "It was like a regular day."

As the months passed, JoAnne settled into her normal routine when Scott was gone. She got Meghan ready for preschool three mornings a week, and on Wednesdays Michael went to a baby-sitting program, Mothers' Day Out, at a local church. Three times a week, JoAnne went to an aerobics class with other Navy wives, and sometimes on Friday nights they'd all meet at a local restaurant for dinner.

Ten days after Scott left, his letters began arriving. They were scrawled on yellow legal paper, and he often signed

them "Spike," his Navy call name. Although JoAnne had never before kept Scott's letters, this time she filed each one lovingly in her top dresser drawer.

JoAnne wanted to write him with only good news, but there was one disappointment: Before Scott left, they had tried to conceive their third child. "I had to write and tell him that it hadn't happened," she says. "I was disappointed. He was, too. Later I felt like there was a reason it hadn't happened."

"Don't worry about it," Scott wrote her in reply. "We'll do it. There's time."

Tensions in the Gulf escalated that fall, and at home JoAnne fought to keep her family life as normal as possible. But a few days after Thanksgiving, the United Nations Security Council passed its historic resolution sanctioning the use of force if Iraqi troops did not leave Kuwait by January 15. As the days ticked away, JoAnne's fear became almost overwhelming.

Her resolution to hide her terror from Scott gave way after Christmas, when she wrote her husband for the first time that she was "scared, really scared." Scott wrote back, "You know that I am completely proficient in this airplane. I'll be home. I guarantee it."

"Why did he keep saying that—I guarantee it?" JoAnne asks softly now. She felt guilty that (continued)

lished for the children, she drove Meghan to preschool.

Though she continued to be troubled by what she didn't know about her husband's death, on the following Sunday—her thirty-second birthday—JoAnne asked a friend to send a telegram to President Bush. "I wanted him to know I wasn't angry," she says now. In the telegram she told the President that she and Scott "supported you then, and I support you now with all my heart."

About a week later, a reply arrived from the White House. The two-page handwritten letter, signed by the President, said, "I am proud of your wonderful husband, and I will never forget him. Sometimes God acts in strange ways—ways we do not understand right away." A separate letter from Barbara Bush added, "I know your precious husband would be so proud of you."

In the next few weeks, letters continued to arrive from Scott—the ones he'd posted in the days preceding his death. Each time one arrived, the woman who delivered the mail carried it to JoAnne's door with tears in her eyes. Inside was page after page of yellow legal paper, filled with Scott's last thoughts. Always, Scott assured her that the *Saratoga's* duties would soon be over and he would be coming home.

Though she appeared to be handling her loss well, emotionally JoAnne was numb. Then on a Wednesday night, two weeks after she'd learned of Scott's death, she sat in the living room with a friend who seemed determined to make JoAnne face her fears and cry. He talked with her until two-thirty A.M., when JoAnne at last admitted that there were things she found too horrible to face: "I didn't want Scott to know. I didn't want him to be scared for one second, I didn't want him to think, 'Oh, no, I'm going down,'" JoAnne remembers. "And I couldn't bear the thought of having a service and having nothing to bury."

Two days later, the brown envelope containing Scott Speicher's most personal effects arrived. Besides his wallet, wedding ring and the gold wings, JoAnne found a white envelope dated January 16, 1991—the day before Scott died. "It was funny," JoAnne says. "All along I knew that there would be one more letter."

"As I sit down to write this letter," Scott wrote, "things in this part of the world seem to grow more intense every hour... I am more certain that our airwing will be called upon... If you are reading this letter, it will be for one of two reasons: 1) I have decided I need to personally share these thoughts with you instead of holding them inside, or 2) Something has happened to

Anne put some snap in her bean

Microwave prepared Good Seasons® Dressing in the cruet for 30 seconds at high. Cruet may be hot. Pour over hot cooked vegetable. You Make It Fresh. You Make It Best.™



me. I hope it is number one."

Scott also wrote separate sections for Meghan, Michael and JoAnne. Each began "I love you." To the children he talked about setting goals and pursuing a good education, being kind to each other and putting God first in their lives.

To JoAnne he wrote, "You are the centerpiece of my life. I have lived with you in complete satisfaction. If I am gone, learn to love again."

Somehow, Scott's letter quieted JoAnne's demons. Since that day, she has felt at peace—with his death, with whatever life brings in the years ahead. She has also come to terms with the way her husband died, reassuring herself that the brilliant light in the sky was Scott's plane instantaneously exploding. She's convinced he had no fear, no indication that those moments were his last. "I'm a survivor. I have to be—I have two kids," she says. "It's what Scott wanted."

"My daddy's in heaven"

Since her husband's death, JoAnne has received hundreds of letters from strangers offering their condolences and their prayers. And the other Navy families—her friends and Scott's—have formed her closest network of support. "They're just like me," she

says. "They're able to act normal. They don't have to worry about not knowing what to say."

JoAnne's children, too, seem to be slowly growing accustomed to their father's absence. But that does not mean they have forgotten: Michael routinely points toward a photo on the living-room wall and says, "Daddy." And on one recent morning, JoAnne asked Meghan if she understood that the *Saratoga* would return and that the other daddies would come home. Meghan answered matter-of-factly, "But my daddy won't, right? My daddy's in heaven." JoAnne smiled sadly at her daughter and said, "That's right."

Later, JoAnne says, "I'm at peace. I feel like it's over, and he is in a better place. I would have been angry if he died in a car crash. This was his life, and Scott wouldn't have wanted it any other way."

What will she say when her children ask about their father? JoAnne doesn't hesitate for a moment. "I'll tell them he was a good man. That he loved them very much and he didn't like to leave. That he loved his job, he loved to fly, he loved his country and he loved God. That he was doing what he had to do. That they should be very proud of him, because he's a hero." ■

Kathryn Casey is a contributing editor of *Ladies' Home Journal*.

Death of a Fighter Pilot

By Mark Crispin Miller

RBALTIMORE Remember how the air war of Operation Desert Storm always looked, or sounded, as if John Ford had directed it? Day after day, U.S. pilots seemed to pick off every enemy jet they aimed at, while the Iraqi pilots always seemed to miss.

"We've destroyed 29 Iraqi aircraft — with not one air-to-air loss on the part of the coalition," claimed Gen. H. Norman Schwarzkopf at a briefing in Riyadh on Jan. 30. "The score is totally one-sided," President Bush asserted at a press conference six days later. "In fact [in] every engagement in the air, the Iraqi planes and pilots have gone down." Newspapers and television generally passed along this version of events, reporting that no allied planes had been shot down.

Eyen after the war, the Pentagon continued to promote a "totally one-sided" air victory. "The Iraqi air force never really got into the air," claims a postwar study by the Air Force. "Those few pilots that did go aloft did not do well." In the Pentagon's final report to Congress, "Conduct of the Persian Gulf War," the claim was repeated: "Coalition planes destroyed 41 Iraqi aircraft and helicopters in air-to-air combat without suffering a confirmed loss to Iraqi aircraft."

But the air war was not quite the shutout that the U.S. propagandists kept extolling. Just hours into Desert Storm, an engagement in the air claimed the war's first U.S. casualty: Lieut. Comdr. Michael Scott Speicher, killed when his plane was blown to bits by an Iraqi MIG-25 — and not, as the Pentagon has told the public, by a ground-to-air missile.

Early on Jan. 17, 1991, Comdr. Mike Anderson was leading Navy Squadron VFA-81 in the first wave of the allied air assault. The squadron — based on the aircraft carrier Saratoga in the Red Sea — was headed north-northeast, at an altitude of roughly 30,000 feet. Because of the nature of the mission, each pilot had to fly alone.

When the team was about 40 miles from its targets, the squadron leader picked up an enemy aircraft some 6,000 feet above him, and speeding in the same direction: "He was going very

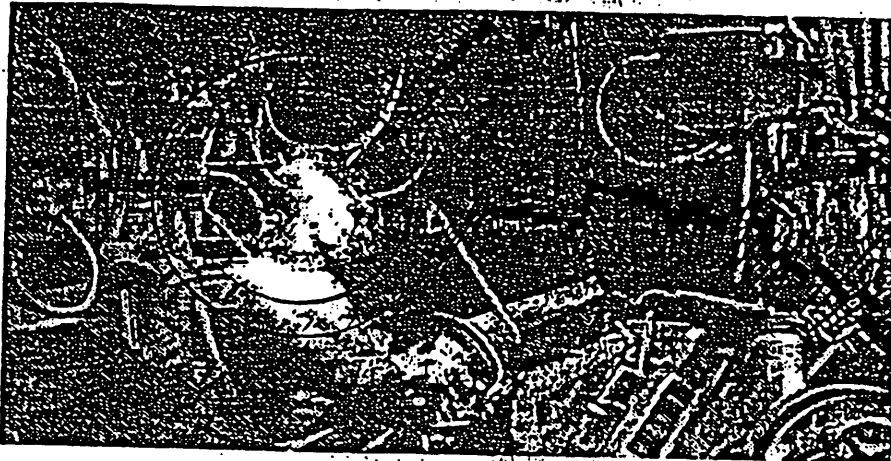

fast," Commander Anderson recalled in a recent interview. "He was headed west-southwest and trying to get around me." As the two planes started circling each other, the squadron leader got a good look at the Iraqi plane: "I got a radar contact on him first, and then I had a visual contact on him. I was very positive it was a MIG-25."

Early in that face-off, Commander Anderson asked repeatedly for permission to shoot. "I kept calling 'MIG-25' to the control agencies — to the Awacs," he said. Such cautiousness was a strict requirement early

ron leader not to fire.

After three turns, the MIG broke away and headed toward the east. Commander Anderson proceeded on his course. A few minutes later, at 3:52 A.M., he was startled by an intense flash. The explosion occurred somewhere off to the east — where Scott Speicher had been flying.

In the military, there was little question as to how the airman died. "The day after he got shot down," recalled Capt. Carlos Johnson, a naval intelligence officer, "I told the people down here at Cecil Field [in Florida] how he got shot down." As director of a Navy research group set up to analyze U.S. air losses during the war, Captain Johnson was immediately sent all pertinent data from the gulf. The group then reconstructed the event. "We were pretty sure at the beginning," said Captain Johnson in a recent interview. "Then, by the end of the war, we were pretty much able to prove that [the attack] was the only logical explanation — other than his aircraft disintegrating."

Captain Johnson deems such "catastrophic aircraft failure" unlikely — nor does anyone believe that the FA-18 was hit by anything launched from the ground. "There were no missiles deployed to the area," Commander Anderson noted. "And at our altitudes, there was no way that a triple-A round [antiaircraft fire] could shoot him down." Nevertheless, Secretary of Defense Dick Cheney announced that a surface-to-air missile had been the likely cause of death.

A cynic might insist that such official lying is a patriotic duty in wartime, for the sake of our morale. Whether just or not, such a rationale is now irrelevant. Yet the lie lives on. Here is the entire official treatment of the incident, as given in the Pentagon's final report. "Fortunately, all but one plane (an FA-18 from the U.S.S. Saratoga) returned safely." A page later, the Speicher episode is further obfuscated by an upbeat description of another event, "a MIG shootdown by an FA-18 pilot, VFA-81,

from U.S.S. Saratoga." The passage — which is anonymous — ends with this suspicious bellow of esprit de corps: "Our relief in having successfully completed the strike without loss to ourselves was overwhelming."

Why this suppression of the facts? The Speicher incident, first of all, disproves the central myth of Desert Storm: that war had now been made predictable — and even safe — by high-technology. In this case, it was not that things were really going wrong, as with our futile air campaign against the Scuds. Rather, the problem here was that a U.S. pilot had died in spite of an efficient system.

"Commander Anderson did what was right," said one Navy pilot who spoke on the condition of anonymity. This airman, who flew in the gulf, was equally supportive of the Awacs personnel. "The guy controlling the situation said, 'No, you don't have enough indicators to say that he's Iraqi, so don't shoot him,'" the airman recalled. "But that kind of thinking probably saved thousands of American lives." Nor had the Awacs malfunctioned. As Commander Anderson admitted, "I can't change physics, nor can anybody else. If [the MIG] was in their Doppler notch, they couldn't see it. They had no evidence a plane was there."

There also seem to be less conscious motivations at work. Those overseeing the gulf war could not face the fact that an Iraqi pilot managed to kill one of our own and get away. Some within the military note the denial underlying the Speicher incident. "I could never for the life of me figure why people don't want to admit that we had an air-to-air loss," wondered one Naval officer, who also spoke on the condition of anonymity. "But that's really the gist of it. It's mostly an ego issue, as far as I'm concerned." That refusal to acknowledge any loss was surely hardened by the American perception of Iraqi "backwardness" — much as in Vietnam, where U.S. officers likewise deemed the enemy too primitive to thwart our gleaming weaponry.

Whatever the reasons for the cover-up, it slights the bravery of the pilots by censoring the dangers that they really faced. More important, the thick cloud of propaganda that was used to sell us Desert Storm betrayed the very notion of democracy, enforcing our wide-eyed support by keeping us all in the dark. "His people have been lied to — denied the truth," President Bush said of Saddam Hussein in a speech to Congress in March 1991. Such systematic lying is indeed outrageous. Could it have happened here? □

Were we lied to about the gulf war's first casualty?

in the air war, when the skies were filled with coalition aircraft. In order to avoid "blue-on-blue" encounters ("friendly fire"), the U.S. Rules of Engagement forbade a pilot's shooting at another plane without approval from the Awacs surveillance radar aircraft, whose crew could, theoretically, tell the good guys from the bad. And so, with that MIG right in front of him, Commander Anderson asked to be allowed to fire.

Permission was refused. "They didn't see him," he said. "My controlling Awacs did not see him."

Why? The Awacs can be fooled by a rare phenomenon called the "Doppler notch." When two aircraft are flying at or near the same speed and in the same general direction, both planes can vanish from the Awacs's radar screens. Unless there was some human error, the MIG seems to have been obscured by this unusual glitch. And so, with no confirming blip before them, the Awacs personnel — quite properly — ordered the squad-

Mark Crispin Miller, professor of media studies at the Johns Hopkins University, is author of the forthcoming spectacle: Operation Desert Storm and the Triumph of Illusion.

Iraqis May Have Downed U.S. Jet in War

Pentagon Concedes Facts of January 1991 Case May Never Be Known

By Peter

The Defense Department conceded yesterday that a U.S. fighter jet could have been shot down by an Iraqi plane during the Persian Gulf War, contrary to earlier statements, but said it probably will never know for sure.

Spokesman Bob Hall made the concession in response to an op-ed piece published in the New York Times yesterday and written by Mark Crispin Miller, a professor at Johns Hopkins University, suggesting that an Iraqi MiG-25 shot down a U.S. F/A-18 fighter plane Jan. 17, 1991, early in the allied air war

against Iraq. "It's one case that may never be closed," Hall said. "If there's no more information to be had, you may never come to a final conclusion."

The Defense Department said for months after the Gulf war that Iraqi planes had not been able to shoot down a single U.S. fighter, but Hall said a final Pentagon report on the war did leave open the possibility of the one shootdown.

Miller in his article quoted Capt. Carlos Johnson, a naval intelligence officer who investigated the crash, as saying he was pretty sure by the end of the Gulf war that the U.S. jet

had been shot down by the Iraqi fighter plane.

Hall said Johnson told the Navy yesterday that the U.S. plane was most likely shot down by the Iraqi plane's missile in his opinion but that it could also have been shot down by a ground-fired missile.

"There are people who have gone over it, analysts who've come to different conclusions," Hall said. "But there was no communication from the plane, no radio calls saying, 'I'm being tracked by a missile' or 'I'm in a dogfight,' plus we never were able to examine the wreckage."

HANES

SEIK REFLECTIONSSM WITH BONUS

Silky StretchSM lingerie in underwire and soft cup bra styles with coordinating pant, camisole, slip and chemise styles. Small to average figures. In nylon/LYCRASM spandex. For sizes 34A-36D, S.M.L. (D.049/231/749) 8.75 to \$29 **BONUS:** Receive a bonus pant with any bra purchase of \$15 or more.

HECHT'S



ITZ CLAIRBORNE PENT

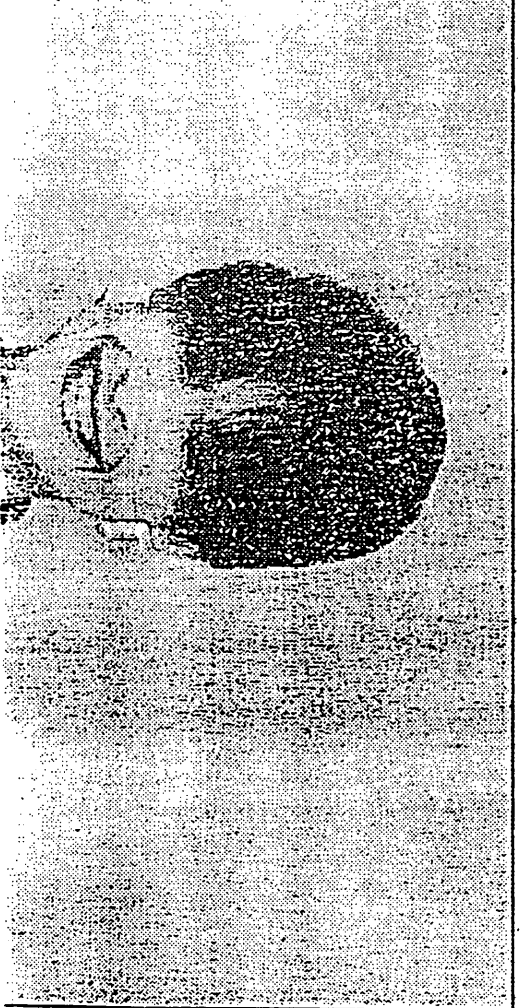

Gre
per!
the:

Shown I
White c
\$100. SI
Rayon j
skirt, \$9
(D.428) Av
Landmark

No Name
DS1-256

ABC/jtl

Office of the Armed Forces Medical Examiner
Armed Forces Institute of Pathology
Washington, E.C. 20306-6000

DATE 26 October 1992

CONSULTATION REPORT ON CONTRIBUTOR MATERIAL

AMP DIAGNOSIS:

1. Fragment of soft tissue measuring 40 x 17 x 2 cm., reported by Iraqi government to be the remains of Michael S. Speicher, an active duty U.S. Naval aviator killed during Operation Desert Storm.
 - A. Soft tissue fragment.
 - B. Hair bearing skin.
 - C. No bone tissue noted.
 - D. DNA testing shows specimen not to be Michael S. Speicher.
2. Toxicology: No evidence of alcohol or other drugs of abuse in submitted specimen.

This was an onscene investigation conducted by the staff of the Office of the Armed Forces Medical Examiner at the port mortuary, Dover AFB, DE. The case has been reviewed and coded as above.

Arthur C. Burns
Arthur C. Burns
CDR, MC, USN
Chief Deputy Medical Examiner

ENVELOPE

CDSN = LGX202 MCN = 91142/35967 TOR = 911421931
 PITUZYUW RUEKJCS2167 1421932-UUUU--RUEALGX.
 ZNR UUUUU

HEADER

P 221932Z MAY 91
 FM JOINT STAFF WASHINGTON DC
 INFO RUCQVAB/USCINCSOC INTEL OPS CEN MACDILL AFB FL
 RUEALGX/SAFE

P 222122Z MAY 91 ZYB
 FM BUPERS WASHINGTON DC//PERS66//
 TO RHFJSBA/COMLATWING ONE CECIL FIELD FL//JJJ//
 RUEDAKA/DFAS-CLEVELAND CENTER CLEVELAND OH//643//
 INFO RUEDAKC/NAVFAMALWACT CLEVELAND OH//JJJ//
 RUFJRJS/STRKFITRON EIGHT ONE
 RHFJSCC/COMCARGRU SEVENTEEN
 RHFJSKA/COMCARAIRWING SEVENTEEN
 RUCKNSA/COMNAVBASE CHARLESTON SC//JJJ//
 RHFJSEA/COMSTRKFIGHTWINGSLANT CECIL FIELD FL//00//
 RULYJRS/USS SARATOGA
 RUEKJCS/SECDEF WASHINGTON DC//OSD-ISA//
 RUHGRPG/COMUSNAVCENT
 RUCJACC/USCINCCENT MACDILL AFB FL//J1//
 RUEKJCS/DIA WASHINGTON DC//POW-MIA//
 ACCT NA-CRADAA

BT

CONTROLS

UNCLAS //N01771//

BODY

SUBJ: CHANGE IN CASUALTY STATUS FROM MIA TO KIA ICO LCDR MICHAEL
 SCOTT SPEICHER, USN, [REDACTED] (b)(6)
 MSGID/GENADMIN/PERS 663//

RMKS/

1. CASUALTY STATUS ICO LCDR MICHAEL SCOTT SPEICHER, USN, [REDACTED] (b)(6)
 IS CHANGED TO KIA FOR ADMINISTRATIVE PURPOSES ON 22 MAY 1991. ACTUAL
 DATE OF DEATH IS 17 JANUARY 1991. RELEASED BY J' L. GREER//

ADMIN

BT

#2167

NNNN

DIA POW/MIA AUTUMATED DATA BASE
 PERSONAL INFORMATION SHEET
 for
 SPEICHER, MICHAEL SCOTT

FIELD NAMES	DATA CONTENTS	EXPLANATION
DATE OF ENTRY.....	= 910125	! (yymmdd)
DATE OF CHANGE.....	= 01/29/91	! (mmdyy)
INCIDENT NO.....	= 1	
DIA RECORD ID NO..	= S0001	
NAME.....	= SPEICHER, MICHAEL SCOTT	
SSN/SERNO.....	= ██████████	
BLOOD CHIT NO.....	= 0 (b)(6)	
RANK.....	= O4	
SERVICE.....	= US NAVY	
INCIDENT DATE.....	= 910117	. (yymmdd)
TIME.....	=	
PLACE OF LOSS.....	=	
COUNTRY LOSS.....	= IRAQ	
COUNTRY MOVED.....	= N/A	
LATITUDE.....	= 325800N	. LOSS LOCATION
LONGITUDE.....	= 0435500E	. IN GEOGRAPHIC
UTM.....	=	. COORDINATES
TYPE OF LOSS.....	= A	
OFF OF SCOPE.....	=	
CASUALTY STATUS...	= MISSING IN ACTION	
CATEGORY REMARKS..	= N/A	
CATEGORY HISTORY..	= DS9101	
DATE OF BIRTH.....	= 57/07/12	. (YYMMDD)
PLACE OF BIRTH....	= KANSAS CITY	
HOME OF RECORD....	=	
SEX.....	= M	
HEIGHT.....	= 71	
WEIGHT.....	= 154	
HAIR.....	= BROWN	
EYES.....	= HAZEL	
RACE.....	= CAUCASIAN	
NATIONALITY.....	= US	
UNIT ASSIGNED.....	= VFA-81	
MOS.....	=	
TYPE OF VEHICLE...	= F/A-18	
VEHICLE CATEGORY..	= ACFT	
VEHICLE NUMBER....	= BU163484	
CREW.....	=	

MO

DIA POW/MIA AUTOMATED DATA BASE
 PERSONAL INFORMATION SHEET
 for
 SPEICHER, MICHAEL SCOTT

FIELD NAMES	DATA CONTENTS	EXPLANATION
MARKS / SCARS.....	=	
PHOTOS.....	= NONE	FOREIGN MEDIA
TAPES.....	= NONE	SUBJ VOICE BCST
RELEASE DATE.....	=	
NEGOT REMARKS.....	= NONE	
NEGOTIATIONS HIST.	= NONE	
ACKNOWLEDGE.....	= NONE	
DETAINING POWER...	= UNDETERMINED	ESTIMATE OF GOV POSSIBLY
ADDITIONAL REMARKS	= FAILED TO RETURN FROM STR IKE MISSION DURING COMBAT ACTION AGAINST IZ. ACFT LAUNCHED 084217Z. A CFT 401 NOT RETURNED. NO FIRM INFO AS TO WHERE/WH EN ACFT LOST, OR FATE OF PILOT. SEARCH INIT IATED. ACTUAL HEIGHT 71. 7".	US INITIATIVES
MISC-1.....	=	extry data field
SCRFLD1.....	=	extry data field
SCRFLD2.....	=	extry data field

END OF DATA REPORT

ATTN: MIKE SASEK

~~SECRET~~
18 JAN 91 0730 L

THIS FORM CLASSIFIED ~~SECRET~~ ^{Secret} ~~INTERASS~~

INFORMATION FOR THE DEFENSE INTELLIGENCE AGENCY
PERTAINING TO USN MIAs, POWs, and KIA/BNR

NAME (LAST, FIRST MI) (1) RANK (1) SSN (1)
SPELCHER, MICHAEL SCOTT LCDR (O-4) [REDACTED] (b)

CASUALTY STATUS (1) ORGANIZATION (1) DATE/TIME OF INCIDENT (1) (b)
DUSTWUN USN, VFA-81 0600 LOCAL / 91 JAN 17 (b)

INCIDENT LOCATION (1) COUNTRY MOVED TO (IF AVAILABLE)
CLASSIFIED

CIRCUMSTANCES OF INCIDENT (1) 455 Saturday morn 076 170842Z Jan 91
FAILED TO RETURN FROM STRIKE MISSION DURING COMBAT

ACTION AGAINST THE FORCES OF IRAQ. A/cft launched as of 0842.
A/cft 403 has not returned. No firm info as to where and when the a/cft was lost or
the fate of pilot. Search initiated.

LOSS COORDINATES (1) (GEOGRAPHICAL) (UTM IF AVAILABLE)

DATE AND PLACE OF BIRTH (2) HEIGHT (3) WEIGHT (3)
570712 KANSAS CITY, MO 71.7" 154

COLOR HAIR (3) COLOR EYES (3) RACE (2) SEX (1)
BROWN HAZEL CAU M

ANY IDENTIFYING REMARKS (TATTOOS, SCARS, ETC.) (3)

TYPE OF VEHICLE (1) VEHICLE IDENTIFICATION NUMBER (1)
F/A-18 AA 403; BU number 163984

- (1) PERSONNEL CASUALTY REPORT AND PROGRESS REPORTS
- (2) DD FORM 1300
- (3) REPORT OF MEDICAL EXAM, SF 88
REPORT OF MEDICAL HISTORY, SF 89

1. Submit this information to DIA/PW-MIA as soon as it becomes available (DIA/PW-MIA, Pentagon, Room 2E230, Washington, DC 20340-5390). Update as needed.

2. This form will be classified according to incident location and loss coordinates.

~~SECRET~~

INQUIRE=DOC13D
ITEM NO=00332398
ENVELOPE
CDSN = LGX361 MCN = 91017/38916 TOR = 910171844
PTTUZYUW RUEKJCS5623 0171842-UUUU--RUEALGX.
ZNR UUUUU

HEADER

P 171842Z JAN 91
FM JOINT STAFF WASHINGTON DC
INFO RUEALGX/SAFE
P 171557Z JAN 91
FM FBIS LONDON UK
TO RUCWAAB/FBIS RESTON VA
RHDIAAA/480TH RTG LANGLEY AFB VA//INPAR//
RHEGLAI/DOE LANL INTELLIGENCE DIVISION//IT/STILLMAN//
PHEGLLL/DOE LAWRENCE LIVERMORE LAB//L-389//
RHEGSNM/SANDIA NATIONAL LABORATORY//9110 PATRICIA NEWMAN//
RUADJHA/CDR500THMIGP CP ZAMA JA//IAGPD-AS//
RUADJNA/DET 4 FTD YOKOTA AB JA
RUCBSAA/USCINCLANT NORFOLK VA//J2//
RUCEAAM/USSPACECOM INTEL CEN CHEYENNE MTN AFB CO//JSIC//
RUCIAEA/FTD/SQHR WRIGHT PATTERSON AFB OH
RUCLBWA/CMDT USACMLS FT MCCLELLAN AL//ATZN-CM-CU//
RUDKMKB/FBIS LONDON UK//BBC//
RUDMNOP/NAVOPINTCEN SUITLAND MD//MAD-821R//
RUDMNSC/NAVTECHINTCEN WASHINGTON DC
RUDMNSC/NAVTECHINTCEN WASHINGTON DC//DS313 DOLORES//
RUEAIIA/ [REDACTED] (b)(3)
RUEANAT/NASA HQ WASHINGTON DC//FOR CODE LD//
RUEATAC/CDR USAITAC WASHINGTON DC//AIAIT-KT//
RUEBHAA/STORAGE CENTER FBIS RESTON VA
RUEBHHA/USNA ANNAPOLIS MD//LANGES-STUD//
RUEDGE/CDR 112TH MI BDE FT DEVENS MA//ATSI-ETP-B-CLP//
RUEHC/SECSTATE WASHINGTON DC//INR/ISD/DC//
RUEHIA/USIA WASHINGTON DC//P/RLS/M/PT//
RUEKJCS/DEFINTAGENCY WASH DC
RUENAAA/CNO WASHINGTON DC//OP-009Y1//
RUEOACC/CDR PSYOPGP FT BRAGG NC//ASOF-POG-SB//
RUEOACC/CDR6THPSYOPBN FT BRAGG NC//AFVS-POS-DD//
RUEOAYC/CDR FSTC INTEL CHARLOTTESVILLE VA//IS3//
RUEORDF/DIR AFMIC FT DETRICK MD//IS//
RUESPF/FBIS CHIVA CHIVA PM
RUETIAL/HQ AFIA FT GEO G MEADE MD//INII FOR BREWER//
RUETIAV/FT GEO G MEADE MD/[REDACTED] (b)(3)
RUETIAV/MPC FT GEO G MEADE MD
RUHQHQA/USCINCPAC HONOLULU HI
RUHQIPA/COMIPAC HONOLULU HI
RUWJBWA/CDR 34TH MI BN GOODFELLOW AFB TX//ATSI-EGF-S3//
RUWJHRA/CDRUSAISC FT HUACHUCA AZ//ATSI-TD-SF LANGUAGE LAB//
RUWMLHB/COMDT DLI MONTEREY CA//FLC PMRY/ATFL-SS-R//
RUWOHEA/NASA JOHNSON SPACE CEN HOUSTON TX//ALICE MARTIN//
ACCT FBLD-EWDK
BT

(b)(3)

(b)(3)

copy to Spec Folder.

CONTROLS
UNCLAS 7Z/TAB/VIDEO

WARNING: FOUO -- DUE TO COPYRIGHT OR OTHER RESTRICTIONS, THIS ITEM IS INTENDED FOR USE ONLY BY U.S. GOVERNMENT CONSUMERS.

WARNING: A VIDEOTAPE OF THE NEWSCAST SUMMARIZED BELOW CAN BE ORDERED FROM THE FBIS TV CENTER. VIDEOTAPES MAY BE ORDERED DIRECTLY FROM FBIS BY CALLING THE FOLLOWING TOLL-FREE NUMBERS: 1-800-542-8660 RPT 1-800-542-8660 AND IN VIRGINIA 1-800-822-5115. TAPES NOT ORDERED WITHIN 30 DAYS WILL BE ERASED.

SERIAL: LD1701155791
BODY
PASS: ATTN TV CENTER
COPY TO MOD (2), LIAISON (3)

COUNTRY: FRANCE
SUBJ: TELEVISION PROGRAM SUMMARY 171200: PAR 91-032

SOURCE: PARIS ANTENNE-2 TELEVISION NETWORK IN FRENCH 1200 GMT 17 JAN 91

TEXT:

///*((RECEPTION: GOOD))*

NEWS *((WHOLE BULLETIN TO BE DEVOTED TO GULF EVENTS))*

1. (0000) AIR ATTACKS LAUNCHED BY ALLIED FORCES ON IRAQ: REPORT OVER VIDEO SHOWING AIRPLANES TAKING OFF FROM RIYADH, FITZWATER ON CNN, BUSH ON TV, CNN FOOTAGE, CHENEY STATEMENT, SADDAM RADIO ADDRESS CITED.

2. (0441) ATTACK LAUNCHED LATER IN KUWAIT: REPORT OVER U.S. POOL VIDEO; CNN, BBC, RADIO BAGHDAD CITED, 12 FRENCH JAGUARS TOOK PART AND FOUR WERE HIT, ONE PILOT SLIGHTLY INJURED.

3. (0618) U.S. TV VIDEO INTERVIEWING U.S. PILOTS AFTER THEIR MISSIONS.

4. (0812) STUDIO REPORTER REVIEWS NEWS: IRNA SAYS U.S. PLANE DOWNED. PILOT EJECTED; BRITISH TORNADO REPORTED MISSING; SAUDI OIL PLATFORMS REPORTEDLY HIT BY IRAQIS; INA SAYS SADDAM SEEN IN STREETS OF BAGHDAD. (NO VIDEO)

5. (0941) CORRESPONDENT DERDA PHONE DISPATCH FROM SAUDI-KUWAIT BORDER TOWN WHICH IS DESERTED, NO GROUND FIGHTING EVIDENT, HE SAYS.

6. (1131) NEWS FROM IRAQ: IRAQI AIR FORCE DID NOT RESPOND TO ATTACK, BAGHDAD RADIO SAID 14 WESTERN PLANES SHOT DOWN. (NO VIDEO)

7. (1150) AUDIO DISPATCH FROM CNN CORRESPONDENT IN BAGHDAD

only U.S. was a No. FBI. NFI. Pilot never from.

← 2 British Tornados downed. in su FTi cir

UNCLASSIFIED

(VOICE IN ENGLISH WITH FRENCH TRANSLATION) ON DAMAGE THERE.

8. (1406) VIDEO REPORT ON ELECTRONIC ASPECT OF GULF WARFARE: CLIPS SHOWN OF RADAR, SURVEILLANCE PLANES.
9. (1613) GEN PESSIDOUS IN THE STUDIO COMMENTS IN GENERAL TERMS ABOUT THE FIRST PHASE OF THE OFFENSIVE.
10. (1740) VIDEO REPORT FROM DHAHRAN ON MOOD THERE AMONG PRESSMEN AND THE POPULATION.
11. (2020) VIDEO REPORT FROM NEW YORK ON REACTIONS OF ORDINARY AMERICANS.
12. (2226) VIDEO REPORT FROM RIYADH CORRESPONDENT ABOUT THE REACTIONS OF THE SAUDI POPULATION.
13. (2446) CAUTIOUS OPTIMISM IN ISRAEL: REPORT OVER VIDEO FROM JERUSALEM CORRESPONDENT INCLUDING CLIP OF PALESTINIAN OFFICIAL FAYSAL AL-HUSAYN.
14. (2642) REPORT OVER VIDEO FROM TEL AVIV ON RELIEF FELT THERE BY LOCAL PEOPLE WHO ARE INTERVIEWED.
15. (2910) BOMBING REPORTED TO HAVE RESUMED IN BAGHDAD, CNN CORRESPONDENT REPORTS (NO VIDEO): KING SAYS SOME IRAQIS HAVE SURRENDERED: CLIP OF KING.
16. (3022) ANXIETY IN AMMAN: REPORT OVER VIDEO OF STREET SCENES AND INTERVIEWING PEOPLE AT HOME.
17. (3227) PLO IN TUNIS CALLS ON ARABS TO OPPOSE U.S. AND EUROPEAN AGGRESSION: VIDEO DISPATCH FROM CORRESPONDENT, ALSO AUDIO INTERVIEW (VOICE IN ENGLISH WITH FRENCH TRANSLATION WITH ABU SHARIF.)
- 18 (3442) IRAQI PLANE SHOT DOWN, CORRESPONDENT IN STUDIO REPORTS.
19. (3511) CHEVENEMENT GAVE NEWS CONFERENCE ABOUT FRENCH MISSION IN KUWAIT: VIDEO EXCERPT.
20. (3645) VIDEO REPORT ON FRENCH PLANES USED IN THIS MORNING" MISSION.
21. (3757) STUDIO COMMENTATOR RACHID ARHAB EXPLAINS THAT FRENCH PLANES WERE UNDER U.S. COMMAND; CHEVENEMENT CLARIFICATION NOTED.
22. (3945) VIDEO REPORT FROM VALENCE ON MORALE AMONG FAMILIES OF THOSE FIGHTING IN THE GULF.
23. (4055) HELPLINE SET UP FOR FAMILIES OF SERVICEMEN: NUMBER GIVEN.

UNCLASSIFIED

24. (4116) CRISIS UNIT HAS ENDED MEETING AT ELYSEE, BRIEF QUOTE OF DUMAS (NO VIDEO).
25. (4200) VIDEO DISPATCH FROM LONDON CORRESPONDENT WITH CLIP OF MAJOR, STREET INTERVIEWS ON GULF EVENTS.
26. (4341) GORBACHEV SAID HE TRIED LAST DEMARCHE TO AVOID WAR. (NO VIDEO)
27. (4400) VIDEO DISPATCH FROM ALGERIA ON MOOD THERE AND NOTING THAT FRENCH ESTABLISHMENTS HAVE BEEN CLOSED.
28. (4544) STUDIO DISCUSSION WITH COMMENTATOR SEBAG AND CHEMICAL WEAPONS EXPERT COLONEL MEYER.
29. (5031) SECURITY STEPPED UP IN FRANCE: VIDEO REPORT SHOWING POLICE CHECKS AND INTERVIEWING AN OFFICIAL OF THE AIR AND BORDER POLICE.
30. (5300) REACTIONS IN FRANCE. FROM POLITICAL FIGURES.
31. (5500) SOCIALIST PARTY SANCTIONS 12 MEMBERS FOR OPPOSING FRENCH POLICY IN GULF. (NO VIDEO)
32. (5519) VIDEO REPORT ON REACTIONS ON WORLD OIL MARKETS TO GULF EVENTS.
33. (5712) STOCK EXCHANGE: VIDEO REPORT.
34. (5818) ANTENNE-2 WILL CONTINUE BROAD COVERAGE OF GULF EVENTS TODAY. SPECIAL EDITION MAGAZINE WILL BE DEVOTED TO GULF CRISIS TONIGHT.

GERMANOS/PG 17/1804Z JAN

ADMIN

BT

#5623

NNNN

UNCLASSIFIED

ENVELOPE

CDSN = LGX202 MCN = 91142/35967 TOR = 911421931
 PTTUZYUW RUEKJCS2167 1421932-UUUU--RUEALGX.
 ZNR UUUUU

HEADER

P 221932Z MAY 91
 FM JOINT STAFF WASHINGTON DC
 INFO RUCQVAB/USCINCSOC INTEL OPS CEN MACDILL AFB FL
 RUEALGX/SAFE

P 222122Z MAY 91 ZYB
 FM BUPERS WASHINGTON DC//PERS66//
 TO RHFJSBA/COMLATWING ONE CECIL FIELD FL//JJJ//
 RUEDAKA/DFAS-CLEVELAND CENTER CLEVELAND OH//643//
 INFO RUEDAKC/NAVFAMALWACT CLEVELAND OH//JJJ//
 RUFKJRS/STRKFITRON EIGHT ONE
 RHFJSCC/COMCARGRU SEVENTEEN
 RHFJSKA/COMCARAIRWING SEVENTEEN
 RUCKNSA/COMNAVBASE CHARLESTON SC//JJJ//
 RHFJSEA/COMSTRKFLIGHTWINGSLANT CECIL FIELD FL//00//
 RULYJRS/USS SARATOGA
 RUEKJCS/SECDEF WASHINGTON DC//OSD-ISA//
 RUHGRPG/COMUSNAVCENT
 RUCJACC/USCINCCENT MACDILL AFB FL//J1//
 RUEKJCS/DIA WASHINGTON DC//POW-MIA//
 ACCT NA-CRADA

BT

CONTROLS

UNCLAS //N01771//

BODY

SUBJ: CHANGE IN CASUALTY STATUS FROM MIA TO KIA ICO LCDR MICHAEL
 SCOTT SPEICHER, USN, [REDACTED] (b)(6)
 MSGID/GENADMIN/PERS 663//

RMKS/

1. CASUALTY STATUS ICO LCDR MICHAEL SCOTT SPEICHER, USN, [REDACTED] (b)(6)
 IS CHANGED TO KIA FOR ADMINISTRATIVE PURPOSES ON 22 MAY 1991. ACTUAL
 DATE OF DEATH IS 17 JANUARY 1991. RELEASED BY J' L. GREER//

ADMIN

BT

#2167

NNNN

UNCLASSIFIED

TELECOPIER TRANSMISSION COVER SHEET
NAVAL AIR WARFARE CENTER
FLEET SUPPORT BRANCH (CODE C3244)
CHINA LAKE, CA 93555



Naval Air Warfare Center
Weapons Division
China Lake, CA 93555

Bruce W. Trenholm
PARACHUTE FLEET SUPPORT BRANCH
ACCIDENT INVESTIGATOR
CODE C3244

COMM: (819) 839-0803
DSN: 437-0803

FAX: (819) 839-8884

TO

AGENCY- SPECIAL OPS

NAME- MAJ. J. PRIOR (USAF)

CODE-

COMMERCIAL PHONE- 695-8119

FACSIMILE PHONE- DSN 225-4493

ADDITIONAL INFORMATION



DEPARTMENT OF THE NAVY
NAVAL AIR WARFARE CENTER
WEAPONS DIVISION
CHINA LAKE, CALIFORNIA 93555-6001

~~SECRET~~

IN REPLY REFER TO:

13512
C3244 (Code 463000D)
7 Sep 94

From: Bruce W. Trenholm, Naval Air Warfare Center Weapons Division
(C3244(Code 463000D)), China Lake CA

Subj: PRELIMINARY EJECTION EVENT ANALYSIS REPORT OF F/A-18 MISHAP

1. Approach

a. The key factors utilized to evaluate the ejection event are the location of the aircraft canopy, the type of seat utilized, and the occupant size. This analysis was of the SJU-5 ejection seat with a 95 percentile (for weight) occupant.

b. The location of the aircraft impact site is less crucial since the aircraft lift surfaces may divert its flight path away from the original course and heading after the ejection event. The canopy, on the other hand, has a more predictable trajectory based on the ejection airspeed, and it generally maintains the original aircraft heading at the point of ejection.

c. Ejection system test data was used to establish the canopy travel distance vs. airspeed. These tests were conducted at the Supersonic Naval Ordnance Research Track (SNORT) facility at China Lake, CA. The trajectory was measured from the film analysis, and it was available in the service release test report from the SJU-5 seat.

d. Knowing the canopy travel distance from this test data, the point in space from which the seat ejected could be predicted, given an initially assumed airspeed and altitude. For this analysis, the airspeed varied from 100 to 500 knots, and the altitude varied from 5000 ft to 25000 ft. For these various conditions, the seat trajectory was predicted using a six degree of freedom computer model.

2. Results (SEE TABLE I - ANALYSIS RESULTS)

3. Ejection Simulation Program

a. The following sections describe the ejection seat model in greater detail.

The six degree of freedom computer model for ejection seats was adapted for the specific application of the SJU-5 ejection seat series. The model applies the forces to the seat and man model in accordance with each of the major ejection phases. Figure 1 illustrates the coordinate systems used for the model. The phases of

~~SECRET~~

~~SECRET~~

Table I: Analysis Results

Altitude (ft)	Aircraft Velocity (knots)	Aircraft Velocity (ft/sec)	Casualty Travel (sec)	Occupant Travel during ejection (ft)	Distance from Casualty to Occupant (ft)
25000	800	840	708	3388	3430
25000	400	672	815	3078	2182
25000	300	504	820	2708	1724
25000	200	336	400	2237	1788
25000	100	168	200	1816	1280
20000	800	840	708	3388	2428
20000	400	672	815	3078	2261
20000	300	504	820	2704	2033
20000	200	336	400	2238	1734
20000	100	168	200	1818	1286
15000	800	840	708	3346	2289
15000	400	672	816	3048	2121
15000	300	504	820	2507	1816
15000	200	336	400	2138	1682
15000	100	168	200	1488	1188
10000	800	840	708	1487	830
10000	400	672	818	1282	488
10000	300	504	820	1073	402
10000	200	336	400	828	327
10000	100	168	200	676	328
5000	800	840	708	1488	820
5000	400	672	818	1282	488
5000	300	504	820	1073	402
5000	200	336	400	828	327
5000	100	168	200	678	328

~~SECRET~~

~~SECRET~~

Subj: PRELIMINARY EJECTION EVENT ANALYSIS REPORT OF F/A-18 MISHAP

aerodynamic loading/drogue deceleration phase, and (d) the recovery parachute phase. The model utilizes numerical integration at very small time steps (.001 sec) to evaluate the forces and moments applied to the seat and occupant in order to obtain incremental changes in displacement and orientation.

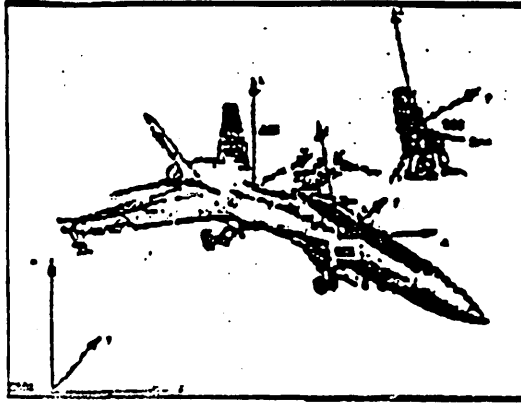

Figure 1: Coordinate Systems for the simulation program.

The locations of all seat components were established in the Seat Coordinate System (SCS). The applied forces and moments were then transformed to the center of gravity of the seat/occupant. All numerical integration was then computed about the center of gravity within the seat coordinate system. In this way, incremental deflections and rotations were of the appropriate magnitude.

b. Catapult Loading

The catapult loading was applied to the ejection seat through thrust-time tables, knowing the point of application and thrust vector. The thrust-time data was found experimentally by the Indian Head Division, Naval Surface Warfare Center (IHD/NSWC) through the use of a thrust stand. The catapult loading is dependent upon the ejected mass.

c. Rocket Motor Loading

The rocket motor loading was applied to the ejection seat via thrust-time tables, knowing the point of application and thrust vector. This point of application and angle varies according to the seat orientation. The thrust-time data was found experimentally utilizing a thrust stand such as those available at the Indian Head Division, Naval Surface Warfare Center (IHD/NSWC). The rocket motor loading is not dependent upon the ejected mass. The analysis utilized the nozzle orientation of the seat in the full down position.

~~SECRET~~

SECRET

Subj: PRELIMINARY EJECTION EVENT ANALYSIS REPORT OF F/A-18 MISHAP

d Aerodynamic Loading

Free stream aerodynamic coefficients of ejection seat platforms have been obtained through wind tunnel facilities. This data, of course, varied with the airspeed (Mach number), air density, and the seat orientation to the wind-stream (pitch and sideslip angles). The resulting data matrix was used for the simulation model. At any orientation, the aerodynamic forces and moments were transformed to the seat center of gravity.

At high speeds, the aerodynamics of the aircraft greatly effects the seat coefficients, particularly in pitch. This effect was shown to be function of the separation distance from the aircraft. The trajectory simulation program utilized multiple aerodynamic tables in order to model this phase of escape.

The importance of the aircraft proximity is that is placed a great deal of demand on the seat stability system. Immediately upon rail separation, aircraft proximity effected the stability of the seat system. The de-stabilization increases greatly with ejection speed. Seat systems which utilize a deployable means of stability are ineffective at this initial stage. By modeling the aircraft proximity effects, the robustness of the stability system can be evaluated.

e. Drogue Deceleration Phase

The SJU-5 system utilizes a single lanyard drogue configuration, attached at the top of the head box via a shackle release mechanism. The purpose of the drogue is to reduce the seat velocity and to align the seat before parachute deployment. The seat was designed to deploy the drogue 0.5 seconds after seat initiation. The timing of the simulation drogue inflation reflects actual sled track test data.

f. Recovery Loading Phase

The SJU-5 system deploys the main parachute at 1.5 seconds after seat initiation. The loads applied by the recovery system depended upon the parachute attachment point, the drag characteristics, and the projected diameter. Empirical data derived from full system test evaluations at the sled track established the time required for deployment. The parachute deployment was divided into two phases (1) deployment to line stretch, and (2) line stretch to first full inflation.

4. Summary

a. The ejection analysis and simulation model has been used extensively over the past few years to enhance the investigator's understanding of an ejection event.

7 (b)(1)

SECRET

~~SECRET~~

Subj: PRELIMINARY EJECTION EVENT ANALYSIS REPORT OF F/A-18 MISHAP

(b)(1)

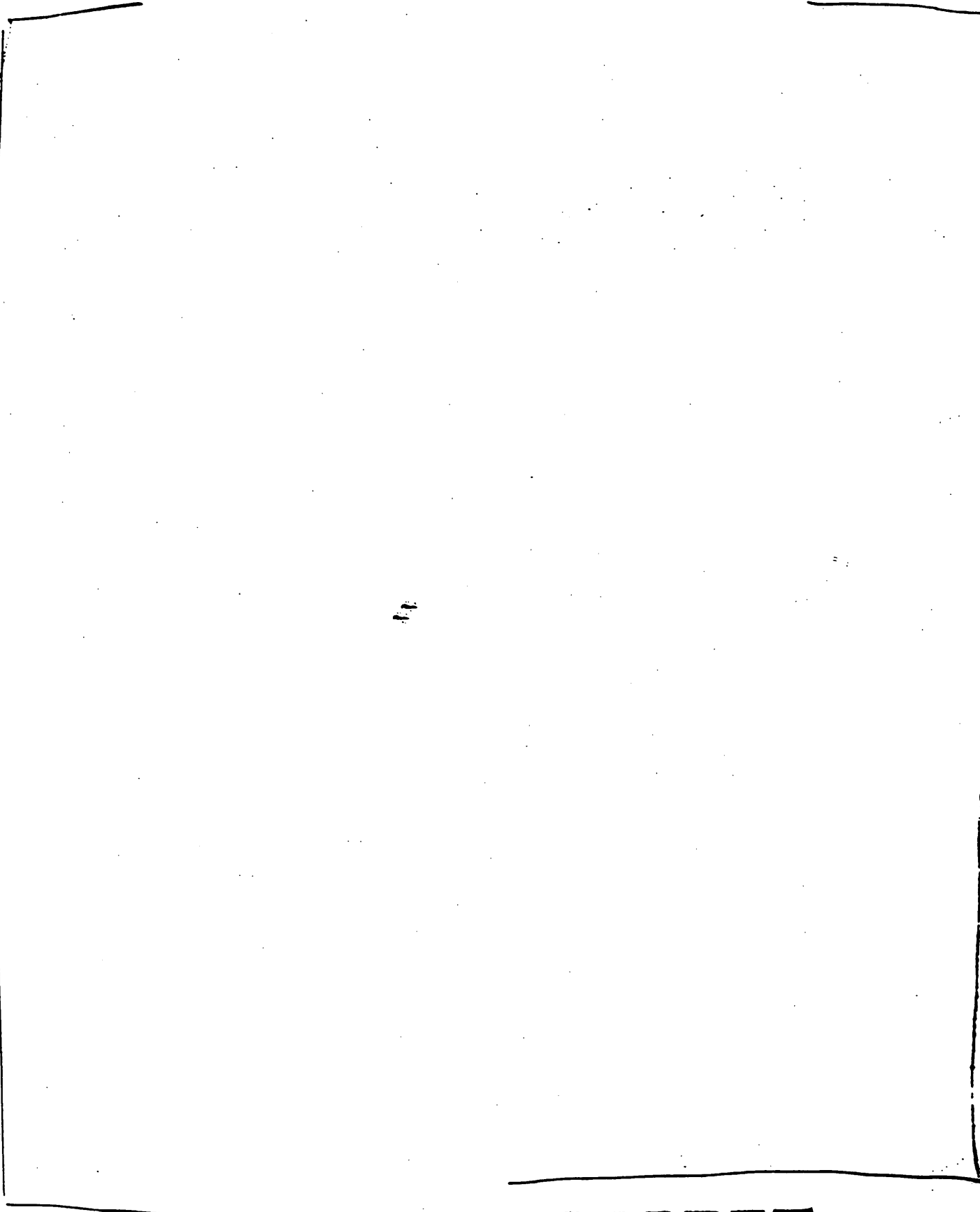

~~SECRET~~

~~SECRET~~

Subj: PRELIMINARY EJECTION EVENT ANALYSIS REPORT OF F/A-18 MISHAP

(b)(1)

5. If further information is required, please contact me at Naval Air Warfare Center Weapons Division (C3244(Code 463000D)), DSN 437-0803 or commercial 619-939-0803.

BRUCE W. TRENHOLM

SECRET

(b)(1)

(b)(1)

AIRCRAFT COMBAT LOSSES

(U) Seven Navy aircraft were either lost or damaged in combat during Desert Storm. Table 5-12 summarizes each incident. The following sections describe in detail each incident originating from the Red Sea and the Persian Gulf.

Table 5-12. Aircraft combat loss/damage summary

~~CONFIDENTIAL~~

Date	Time (C)	ACFT	CV	Evt	Location	Cause	Aircrew ¹ Outcome
17 Jan	0352	F/A-18	Saratoga	Loss	3300N/04220E	Unk	1 MIA
17 Jan	2300	A-6	Saratoga	Loss	3306N/03941E	SAM AAA	2 POW
17 Jan	2300	A-6	Saratoga	Dmgd	3256N/03945E	SAM	Diverted
18 Jan	1851	A-6	Ranger	Loss	2958N/04758E	Unk	2 KIA
21 Jan	0610	F-14	Saratoga	Loss	3330N/04200E	SAM	1 rescued 1 POW
2 Feb	1115	A-6	Roosevelt	Loss	2927N/04814E	Unk	1 MIA 1 KIA
11 Feb	1410	A-6	Roosevelt	Dmgd	2930N/04825E	AAA	Diverted

1. Outcome reflects status as of 28 Feb 91

~~BEYOND SCOPE OF REQUIREMENTS~~

RELEASE DFOISR

Red Sea Battle Force

(U) Four aircraft from the Red Sea carriers were lost due to enemy fire during the first few days of Desert Storm—all from *Saratoga*. Three of these aircraft crashed, and the remaining aircraft diverted to Al Jouf. This fourth aircraft was considered a loss because it was unflyable and beyond repair. The following paragraphs describe the reconstruction results of each aircraft loss.

(b)(1)

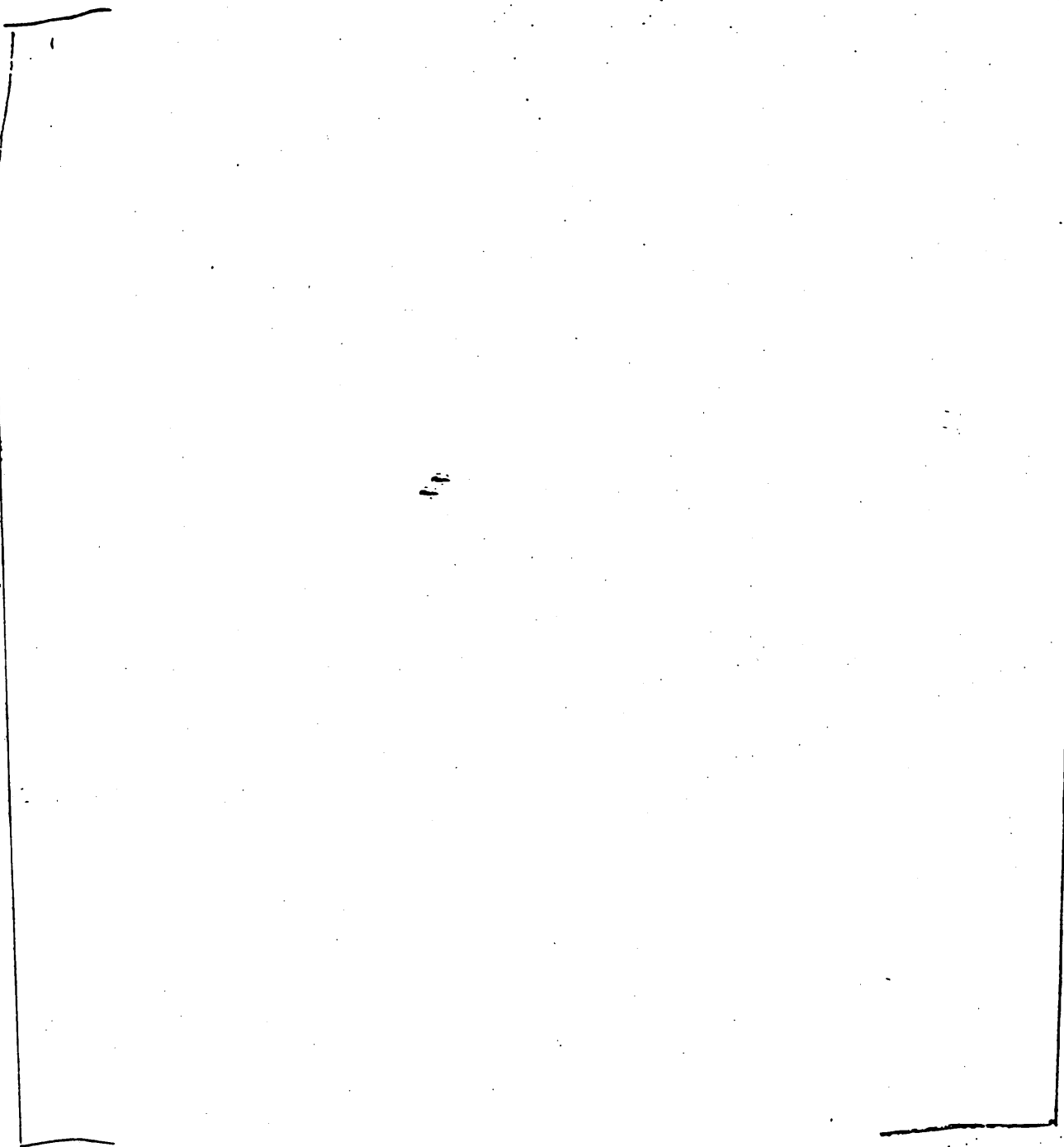

b
(c)

~~SECRET~~

(b)(1)

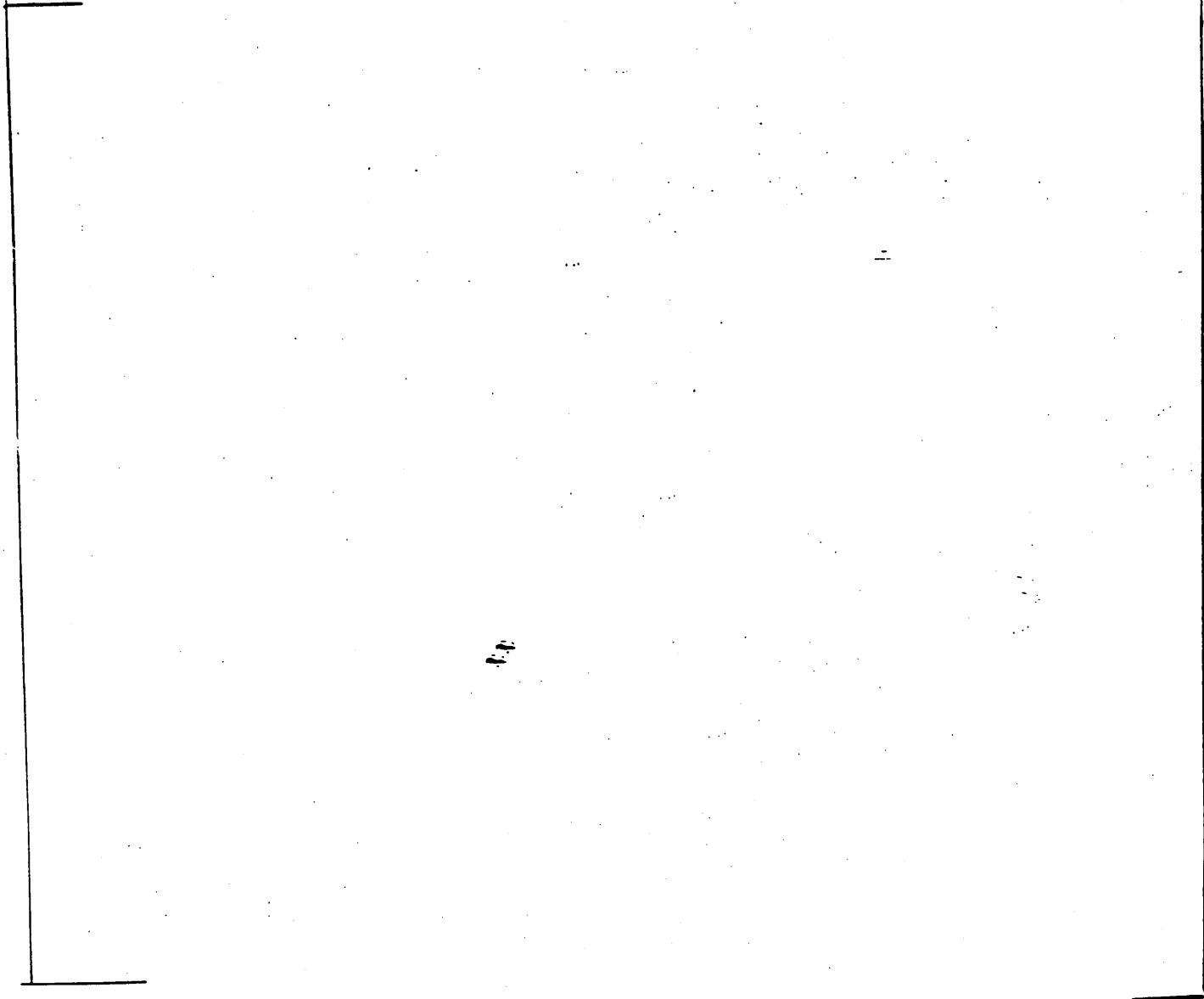

~~SECRET~~

ENVELOPE

CDSN = LGX273 MCN = 91109/39358 TOR = 911092000
OTTTCZYUW RUEKJCS3275 1092000-CCCC--RUEALGX.
ZNY CCCCC

HEADER

O 192000Z APR 91
FM JOINT STAFF WASHINGTON DC
INFO RUEALGX/SAFE
O 191936Z APR 91 ZYB ZFF-1
FM COMNAVMILPERSCOM WASHINGTON DC//NMPC66//
TO RHIPAAA/USCINCCENT//CCJ1//
INFO RUHGOAA/COMUSNAVCENT
RHIPAAA/NAVCENT RIYADH SA//JJJ//
RHSIKMC/SOCCENT FWD//J1//
RUEKJCS/DIA WASHINGTON DC//POW-MIA//
RUEBEJA/USAF PORT MORTUARY DOVER AFB DE//JJJ//
RHIUFAA/COMUSCENTAF//DP/JRCC//
ACCT NA-CRADA

Copy to

Chrono
Speicher
Cooke
Connor
Costen
Turner

BT

CONTROLS

~~CONFIDENTIAL~~ //NO1770//

BODY

SUBJ: CASUALTY STATUS
MSGID/GENADMIN/NMPC 663//
REF/A/RMG/USCINCCENT/181100ZAPR91//
REF/B/RMG/COMNAVMILPERSCOM WASHINGTON DC/112121ZAPR91/-/NOTAL//
REF/C/RMG/COMNAVMILPERSCOM WASHINGTON DC/232121ZMAR91/-/NOTAL//
RMKS/1. AS REQUESTED BY REF A FOLLOWING CASUALTY STATUS

APPLIES:

- 1. LCDR MICHAEL SPEICHER MIA
- 2. LT PATRICK CONNOR KIA, STATUS CHANGED 11 APR, REPORTED BY REF B
- 3. LT WILLIAM COSTEN KIA, STATUS CHANGED 23 MAR, REPORTED BY REF C
- 4. LT CHARLES TURNER KIA, STATUS CHANGED 23 MAR, REPORTED BY REF C
- 5. LCDR BARRY COOKE, IS ALSO MIA. HIS NAME IS NOT CONTAINED IN REF A NOR HAS HIS NAME BEEN ASSOCIATED WITH SHIPMENT OF ANY REMAINS.
- 6. NO STATUS CHANGE FOR LCDRS SPEICHER AND COOKE ANTICIPATED AT THIS TIME. RELEASED BY J. L. GREER//

(b)(6)

ADMIN

BT

#3275

NNNN

~~CONFIDENTIAL~~

AIMFULL

TO : DIROSDM
FROM : DITRAJB
SUBJECT: 191135ZAPR912980
DOCUMENT SENT ON 04/19/91

ENVELOPE

CDSN = LGX537 MCN = 91109/21258 TOR = 911091144
PTTCZYUW RUEKJCS2980 1091145-CCCC--RUEALGX.
ZNY CCCCC

HEADER

P 191145Z APR 91
FM JOINT STAFF WASHINGTON DC
INFO RUEALGX/SAFE
P R 191135Z APR 91
FM USCINCCENT//CCJ1//
TO RHWRMPC/HQ AFMPC RANDOLPH AFB TX//DPMACAC//
RUEACNP/COMNAVMILPERSCOM WASHINGTON DC//66//
INFO RUEKJCS/JOINT STAFF WASHINGTON DC//J1/J5//
RUEKJCS/DIA WASHINGTON DC//POW-MIA//
RHIUFAA/COMUSCENTAF//DP//
RHIUFAA/COMUSCENTAF//JRCC//
RUHGOAA/COMUSNAVCENT//N1//
RUCJACC/USCENTCOM REAR MACDILL AFB FL//CCJ1//
ZEN/NAVCENT RIYADH SA//

*Copy to Chrono +
named ind.*

BT

CONTROLS

~~C O N F I D E N T I A L~~
MINIMIZE CONSIDERED

BODY

MSGID/SYS.RRM//
AMPN/MIA CASUALTY STATUS//
RMKS/1. EFFECTIVE 200001Z APRIL 91, THE USCENTCOM JOINT CASUALTY
RESOLUTION FUNCTION WILL REVERT TO: USCENTCOM J1, MACDILL AFB FL.
REQUEST ADDRESSEES MAKE WIDEST DISSEMINATION TO APPROPRIATE AGENCIES
AND ESURE THAT THIS PLAD IS UTILIZED TO KEEP USCENTCOM AWARE OF
CASUALTY STATUS CHANGES.

2. THE FOLLOWING CASES ARE STILL OPEN:

LCDR SPEICHER, LCDR COOKE

THE FOLLOWING CASES HAVE HAD RECENT DEVELOPMENTS WHICH MAY
NECESSITATE A STATUS CHANGE:

USAF: MAJ KORITZ, MAJ HOLLAND, CAPT PHILLIS

USN: LT COSTEN, LT TURNER, LT CONNOR

3 KIA

3. POC AT MACDILL AFB IS MAJ BAGLEY, DSN 968-6621.//

ADMIN

DECL/OADR//

CLOSTEXT//

BT

#2980

NNNN

~~CONFIDENTIAL~~

~~SECRET~~
~~SECRET~~
~~SECRET~~
ENVELOPE

CDSN = LGX234 MCN = 91092/00586 TOR = 910920021
PTTSZYUW RUEKJCS7381 0920021-SSSS--RUEALGX.
ZNY SSSSS

HEADER

P 020021Z APR 91
FM JOINT STAFF WASHINGTON DC
INFO RUFGAID/USEUCOM AIDES VAIHINGEN GE
RUEKCCG/USDP-CCC WASHINGTON DC
RUETIAQ/MPCFTGEORGE GMEADEMD
RUEAIIA/CIA WASHINGTON DC
RUEHC /SECSTATE WASHINGTON DC
RUCQVAB/USCINCSOC INTEL OPS CEN MACDILL AFB FL
RHEPAAB/TAC IDHS LANGLEY AFB VA//IDHS//
RUFTAKA/USA INTEL CENTER HEIDELBERG GE
RUFTAKC/UDITDUSAREUR HEIDELBERG GE
RUDOGHA/USNMR SHAPE BE//SURVEY//
RUEALGX/SAFE

Copy to Chrono
[Stade
debriefs]
Speicher

P 011105Z APR 91

FM CTG ONE SIX EIGHT PT ZERO//00//
TO RUEKJCS/JOINT STAFF WASHINGTON DC//OCJCS-PW-MIA/J5//
RHEHAAA/NATIONAL SECURITY COUNCIL WASHINGTON DC//
RUEKJCS/SECDEF WASHINGTON DC//OASD-ISA/PW-MIA// (63)
RUEKJCS/DIA WASHINGTON DC//POW-MIA//
RUENAAA/CNO WASHINGTON DC//OP092/OP01/OP05/OP06/OP07//
RUEACMC/CMC WASHINGTON DC//JJJ//
RUCBSAA/USCINCLANT NORFOLK VA//J2//
RUCBSAA/CINCLANTFLT NORFOLK VA//N2//
RHIPAAA/USCINCCENT//CCJ2//
RHIHDA/COMSOPCENT//J2//
RUEOFAA/COMJSOC FT BRAGG NC//J2//
RUCJACC/USCENTCOM REAR MACDILL AFB FL//J2//
RUEADWD/HQ DA OSCAR WASHINGTON DC//JJJ//
RUEAHQA/CSAF WASHINGTON DC
RULKNIS/COMNISCOM WASHINGTON DC//22//
RUCOAIR/COMNAVAIRLANT DATA NORFOLK VA//20//
RUHGOAA/COMUSNAVCENT//JJJ//
RUWFMAA/COMNAVAIRPAC DATA SAN DIEGO CA//N2//
RUEKJCS/OASD WASHINGTON DC//FM-P (P1-A-LLP)//
RUKGNBA/HQ AFIA FT BELVOIR VA//INU//
RUDMCTF/CTF ONE SIX EIGHT//CTF-HO/CTF-HR/CTF-HP//
RUEADWD/DA WASHINGTON DC//DAMI//
RUDMNIC/COMNAVINTCOM WASHINGTON DC//00//
RUDMNOP/NAVOPINTCEN SUITLAND MD//SPEAR//

BT

CONTROLS

~~SECRET~~ ~~SECRET~~ ~~SECRET~~ ~~SECRET~~ //NO3800//

THIS IS AN OPERATION YELLOW RIBBON REPORT. RELEASABLE BY SERVICE
CASUALTY DIVISIONS ONLY. FOR YELLOW RIBBON ACTION OFFICERS ONLY.
SERIAL: (U) IIR 5 300 0237 90.

BODY

COUNTRY: (U) IRAQ (IZ).

~~SECRET~~

~~SECRET~~

~~SECRET~~

~~SECRET~~

~~WNINTEL~~

~~NOFORN~~

~~DIS~~

PAGE:0010

SUBJ: (U) IIR 5 300 0237 91/PRISONER OF WAR REPORT - DESERT STORM (U).
WARNING: (U) THIS IS AN INFORMATION REPORT, NOT FINALLY EVALUATED INTELLIGENCE. REPORT CLASSIFIED S E C R E T/WNINTEL/NOFORN.
DEPARTMENT OF DEFENSE

DOI: (U) 910304.
REQS: (U) T-8C2-2650-01; HQ AF/INU DEBRIEFING GUIDE.
SOURCE: (~~XXXXXXXXXX~~) //OTS 5300-0091-91// IS A U.S. NAVY F14A(PLUS) RADAR INTERCEPT OFFICER (RIO) WHO WAS SHOT DOWN OVER IRAQ ON 21 JANUARY 1991 AND HELD AS A PRISONER OF WAR (POW).
SUMMARY: (~~XXXXXXXXXX~~) THIS REPORT PROVIDES INFORMATION ON A COMMENT MADE BY AN IRAQI INTERROGATOR CONCERNING THE STATUS OF A U.S. NAVY F18 PILOT.

TEXT: 1. (~~XXXXXXXXXX~~) INTERROGATOR COMMENT ON USS SARATOGA LOSSES. AT ONE OF SOURCE'S INTERROGATIONS, SOURCE WAS TOLD A F18 PILOT OFF USS SARATOGA WAS DEAD (NFI). (FIELD COMMENT--THIS MAY CORRELATE TO LIEUTENANT COMMANDER SPEICHER, USN. SOURCE DOES NOT RECALL WHICH INTERROGATOR, NOR AT WHICH SITE AND SESSION THIS COMMENT WAS MADE.) THE COMMENT WAS MADE IN THE CONTEXT OF AN ATTEMPT TO ELICIT INFORMATION CONCERNING AIRWING PERSONNEL. SOURCE WAS ASKED IF USS SARATOGA LOST ANY AIRCRAFT. SOURCE SAID YES, A F18 AND AN A6. SOURCE WAS ASKED IF HE KNEW THE PILOT OF THE F18. SOURCE REPLIED NO. THE INTERROGATOR WAS UPSET, AS HE BELIEVED THE AIRWING WAS A TIGHT-KNIT FAMILY AND SOURCE SHOULD KNOW THE PILOT. THE INTERROGATOR STATED, "WELL, HE'S DEAD." SOURCE WAS GIVEN NO SUBSTANTIVE INFORMATION. (FIELD COMMENT--IN RETROSPECT, BASED ON THE INTERROGATION'S SUPERFICIALITY AND THE WIDESPREAD PUBLICATION OF LCDR SPEICHER'S STATUS, SOURCE BELIEVES THE INTERROGATOR OBTAINED THE INFORMATION FROM THE PRESS.)

COMMENTS: (U) THIS IS THE FOURTH IN A SERIES OF REPORTS WHICH ADDRESSES ISSUES DISCUSSED IN THE HQ AF/INU DEBRIEFING GUIDE.

//IPSP: (U) PG1100//.

//COMSOBJ: (U) 111//.

ADMIN

PROJ: (U) 503100.
INSTR: (U) U.S. NO.
PREP: (U) HENRY CORSCADDEN, LCDR, USNR, TG 168.0; RAYMOND LAGAMASINO, LT, USNR, TF 168.
ACQ: (U) WASHINGTON, DC (910312).
WARNING: (U) REPORT CLASSIFIED S E C R E T--WARNING NOTICE- INTELLIGENCE SOURCES OR METHODS INVOLVED-NOT RELEASABLE TO FOREIGN NATIONALS.

DECL/OADR//

BT

#7381

NNNN

~~SECRET~~

~~WNINTEL~~

~~NOFORN~~

~~DIS~~

MSG 005
PRIORITY

DATE: 081
TIME: 1221

*Copy to Chrono
[Phillis] P
Speicher*

PATUZYUW RHSIKMC0996 0811219-UUUU--RHWRCCC.
ZNR UUUUU
P 221200Z MAR 91
FM CDR 689 QM CD KKMC SA//09734//
TO RUCINAA/436 SVC DOVER AFB DE//SVM//
RUEBEJA/CJMAO ORG DOVER AFB DE//
RUDCHAA/COMUSARCENT MAIN//G-4//
RHIPAAA/CINCUSCENTCOM//J4//JMAO//
INFO RHSIKMC/CDR 22 SUPCOM//ACSLOG-SVCS//
RUFTRWA/322 ALD RAMSTEIN AB GE//ALCC//
RUEAHOF/CJMAO ALEX VA//
RUEAHOF/CDR PERSCOM ALEX VA//
RHCUAAA/USTRANSCOM SCOTT AFB IL//CAT//
RHCUAAA/HQ MAC SCOTT AFB IL//CAT//
RUEKJCS/JCS WASH DC//J-4LRC//
RHSIKMC/COMNAVLOGSUPPORT
RULSSAA/COMNAVMECOM WASH DC//CODE 332//
RULSSAA/COMNAVMIIPERSCOM WASH DC//N-122//
RHWRMFC/HQ AFMPC RANDOLPH AFB TX//DPMCA//
RUCIBBA/COMUSCENTAF SHAW AFB SC//DEH/LGT//
RHIUFMA/USCENTAF FWD//
RHSIKMC/TSRT KKMC

*Where did the extra
set of remains come
from. Lt. Mahoney hasn't
heard anything. This
msg raises several
questions.*

PAGE 02 RHSIKMC0996 UNCLASS FOUO
BT

UNCLASS FOUO

SUBJECT: TRANSPORTATION - HUMAN REMAINS

1. THE FOLLOWING US NAVY/AIR FORCE PERSONNEL (DISASSOCIATED PORTIONS
ARE ENROUTE TO DOVER AFB DE VIA C-5 AIRCRAFT MISSION NUMBER 21475
TAIL NUMBER 00453 ETD 0721 22 MARCH 1991:

BTB	RANK	SSAN	DOD	TCN
*PHILLIS, STEVEN R.	CPT	UNK	UNK	<u>KSA-149</u>
SPEICHER, MICHAEL	LCDR	UNK	UNK	<u>KSA-150</u>
BT				
#0996				

Copy to Chrono
Conner
Cooke
Costen
Dwyer
Holland
Koritz
Phillis
Speicher

DTG: 071800Z MAR 91
FM: NMIST CENTCOM//CCJ2-C1//
VIA: NMIST NET
TO: NMIST DIA WASHINGTON DC//
INFO: ALL STATIONS

PASS TO: DIA//POW-MIA//

SECRET LIMDIS

SUBJECT: STATUS OF AMERICAN POWS (U)

1. (U) THE FOLLOWING US POWS WERE RELEASED TO THE INTERNATIONAL COMMITTEE FOR THE RED CROSS (ICRC) ON 4 MAR 91 AND HAVE BEEN RETURNED TO COALITION CUSTODY. ALL WERE TRANSPORTED TO THE USHS MERCY CURRENTLY DOCKED IN BAHRAIN. ALL APPEAR TO BE IN GOOD CONDITION.

Spella
Turne
Underwa

USAF MAJ THOMAS GRIFFITH
USA SPC DAVID LOCKETT
USA SPC MELISA NEALY
USN LT LAWRENCE SLADE
USN LT ROBERT WETZEL
USN JEFFREY ZAUN

~~AA~~

RELEASE
DFI STC

2. (U) THE FOLLOWING US POWS WERE RELEASE TO THE ICRC ON 5 MAR 91 AND WERE RETURNED TO COALITION CUSTODY 6 MAR 91. ALL WERE TRANSPORTED FROM BAGHDAD TO RIYADH AIR BASE, SA ON 6 MAR 91 AND WERE SUBSEQUENTLY TRANSFERRED TO THE MERCY. TWO WERE LISTED AS NON-AMBULATORY, MAJ CORNOM (BROKEN ARMS) AND CAPT ANDREWS (LOWER EXTREMITIES, TRAUMA).

USMC LTC CLIFFORD M. ACREE
USAF CAPT WILLIAM F. ANDREWS
USMC CAPT MICHAEL C. BERRYMAN
USAR MAJ RHONDA L. CORNOM
USAR SPC TROY A. DUNLAP
USAF COL DAVID W. EBERLY
USAF LTC JEFFERY D. FOX
USMC CWO4 GUY L. HUNTER
USAF CAPT HARRY M. ROBERTS
USMC CAPT RUSSELL A. SANBORN
USMC MAJ JOSEPH J. SMALL III
USAR SPC DANIEL J. STAMARIS
USAF CAPT RICHARD D. STORR
USAF LT ROBERT J. SWEET
USAR MAJ JEFFERY S. TICE

3. (FOUO) ACCORDING TO J1 (PW/MIA), THE TWO USAR INDIVIDUALS, SPC DAVID BUSH AND SSG CRYSTAL L. RICKETT LISTED AS MIA ON 4 MAR 91 (MISSING FROM CONVOY) WERE LOCATED IN US CUSTODY. BUSH AND RICKETT WERE SEPARATED FROM THEIR UNIT AND MANAGED TO ATTACH TO

~~SECRET~~

ANOTHER UNIT.

4. (S/LIMDIS) INITIAL DEBRIEF WITH MAJ SMALL INDICATES HE WAS RESPONSIBLE FOR EJECTING BOTH HIMSELF AND HIS CREW MEMBER CAPT DAVID M. SPELLACY DURING HIS DEBRIEFING. SMALL SAID THAT DURING HIS DESCENT HE NOTICED SPELLACY'S PARACHUTE HAD DEPLOYED. HE ALSO NOTICED THAT SPELLACY'S BODY APPEARED TO BE LIFELESS. DURING AN EARLIER CONVERSATION WITH COL CLARK, CCJ1, SMALL STATED THAT SPELLACY'S PARACHUTE DEPLOYED ONLY PARTIALLY. SMALL INDICATED TO DEBRIEFERS THAT DURING INTERROGATION BY HIS IRAQI CAPTORS, THEY TOLD HIM "HIS PARTNER" WAS DEAD AND THEY HAD BURIED HIM.

5. (S/LIMDIS) THE WRECKAGE OF THE AV-8B PILOTED BY USMC CAPT JAMES W. WILBOURN, WHO WAS REPORTED MIA ON 23 FEB 91, WAS LOCATED ON 4 MAR 91. IN THE WRECKAGE, REMAINS WERE FOUND WHICH WERE POSITIVELY IDENTIFIED AS WILBOURN'S ON 6 MAR 91 (REF: VMA 542 MSG, 041515Z MAR 91, PCR DEATH SUPPLEMENTAL).

6. (S) ON 7 MAR 91, FLT SWEET, AN A-10 PILOT, WHO WAS THE WINGMAN FOR CAPT STEPHEN PHILLIS, RELATED PHILLIS' AIRCRAFT WENT DOWN WITHIN 5 TO 10 MILES OF GRID COORDINATES 3002N 04715E. THIS INFORMATION WAS PASSED TO CAPT REYNOLDS, SOCCENT, ON 7 MAR 91.

7. (S/LIMDIS) DIVERS HAVE RECOVERED SOME REMAINS AT THE CRASH SITE OF THE AC-130H DOWNED OVER WATER ON 310320Z JAN 91. SAR ACTIVITIES ARE STILL ONGOING, BUT INDICATIONS ARE THAT THIS CRASH WAS NOT SURVIVABLE. A BOARD IS SCHEDULED TO CONVENE NEXT WEEK TO MAKE A FINAL DETERMINATION CONCERNING THE STATUS OF THE CREW MEMBERS.

8. (U) THE FOLLOWING PERSONNEL ARE STILL BEING CARRIED AS MIA:

(b)(6)

BLAND, THOMAS C.
SSAN: [REDACTED]
RANK: TLT
SERVICE: AF
UNIT: 16 SOS (AFSOC)
DTG LOST: 310326Z JAN 91
COORD: 2844N 04816E
STATUS: PKIA
VEHICLE: AC-130H
RECORD NO.: 36
COMMENTS: AIRCRAFT PROBABLY DOWN AT SEA.

on land, not over water 1 mile of coast

(b)(6)

BLESINGER, JOHN P.
SSAN: [REDACTED]
RANK: SSGT
SERVICE: AF
UNIT: 16 SOS (AFSOC)
DTG LOST: 310326Z JAN 91
COORD: 2844N 04816E
STATUS: PKIA
VEHICLE: AC-130H

RECORD NO.: 43
COMMENTS: AIRCRAFT PROBABLY DOWN AT SEA

b6

BUEGE, PAUL G.
SSAN: [REDACTED]
RANK: MSGT
SERVICE: AF
UNIT: 16 SOS (AFSOC)
DTG LOST: 310326Z JAN 91
COORD: 2844N 04816
STATUS: PKIA
VEHICLE: AC-130H
RECORD NO.: 37
COMMENTS: AIRCRAFT PROBABLY DOWN AT SEA

b6

CLARK, BARRY M.
SSAN: [REDACTED]
RANK: SGT
SERVICE: AF
UNIT: 16 SOS (AFSOC)
DTG LOST: 310326Z JAN 91
COORD: 2844N 04816E
STATUS: PKIA
VEHICLE: AC-130H
RECORD NO.: 45
COMMENTS: AIRCRAFT PROBABLY DOWN AT SEA.

b6

CONNER, PATRICK K.
SSAN: [REDACTED]
RANK: LT (O-3)
SERVICE: NY
UNIT: VA 36, USS ROOSEVELT
DTG LOST: 021143Z FEB 91 (J1) 02840Z FEB 91 (JRCC)
COORD: 2924N 04820E, NEAR FALAKA ISLAND
STATUS: PKIA
VEHICLE: A-6E
CALLSIGN: HRTLSS 21
RECORD NO.: 51
COMMENTS: DOWN IN WATER - NO BEACON OR VOICE. WITH COOKE AT TIME SHOT DOWN.

b6

COOKE, BARRY T.
SSAN: [REDACTED]
RANK: LCDR (O-4)
SERVICE: NY
UNIT: VA 36, USS ROOSEVELT
DTG LOST: 022240Z FEB 91 (J1) 020840Z FEB 91 (JRCC)
COORD: 2924N 04820E, NEAR FALAKA ISLAND
STATUS: PKIA
VEHICLE: A-6E
CALLSIGN: HRTLSS 21
RECORD NO.: 50
COMMENTS: DOWN IN WATER - NO BEACON OR VOICE. WITH CONNER AT

TIME SHOT DOWN.

(b)(6)

COSTEN, WILLIAM T.
 SSAN: [REDACTED]
 RANK: LT (O-3)
 DOB: 08/03/63
 SERVICE: NY
 UNIT: VA-155, USS RANGER
 DTG LOST: 181540Z JAN 91
 COORD: 3000N 04800E
 STATUS: PMIA
 VEHICLE: A6-E
 CALLSIGN: JAKAL 11
 RECORD NO.: 6
 COMMENTS: CREWMEMBER WAS LT TURNER. LAST SEEN OVER ARABIAN GULF. SAR SUSPENDED.

(b)(6)

DWYER, ROBERT J.
 SSAN: [REDACTED] OR [REDACTED]
 RANK: LT (O-3)
 SERVICE: NY
 UNIT: CVW-8 DET, VFA-87, USS ROOSEVELT
 DTG LOST: 051700Z FEB 91
 COORD: 2915N 04850E (J1) 2915N 04845E (JRCC)
 STATUS: PKIA
 VEHICLE: FA-18
 CALLSIGN: PARTY 01
 RECORD NO.: 53
 COMMENTS: OVER WATER LOSS. DISAPPEARED FROM RADAR. SAR SUSPENDED POSSIBLY IN IRAN.

(b)(6)

GALVIN, ARTHUR
 SSAN: [REDACTED]
 RANK: CAPT
 SERVICE: AF
 UNIT: 16 SOS (AFSOC)
 DTG LOST: 310326Z JAN 91
 COORD: 2844N 04816E
 STATUS: PKIA
 VEHICLE: AC-130H
 RECORD NO.: 34
 COMMENTS: AIRCRAFT PROBABLY DOWN AT SEA

(b)(6)

GRIMM, WILLIAM D.
 SSAN: [REDACTED]
 RANK: CAPT
 SERVICE: AF
 UNIT: 16 SOS (AFSOC)
 DTG LOST: 310326Z JAN 91
 COORD: 2844N 04816E
 STATUS: PKIA
 VEHICLE: AC-130H
 RECORD NO.: 35

COMMENTS: AIRCRAFT PROBABLY DOWN AT SEA.

HARRISON, TIMOTHY R.

SSAN: [REDACTED]
RANK: SSG
SERVICE: AF
UNIT: 16 SOS (AFSOC)
DTG LOST: 310326Z JAN 91
COORD: 2844N 04816E
STATUS: PKIA
VEHICLE: AC-130H
RECORD NO.: 44

b6

COMMENTS: AIRCRAFT PROBABLY DOWN AT SEA.

HODGES, ROBERT K.

SSAN: [REDACTED]
RANK: TSGT
SERVICE: AF
UNIT: 16 SOS (AFSOC)
DTG LOST: 310326Z JAN 91
COORD: 2844N 04816E
STATUS: PKIA
VEHICLE: AC-130H
RECORD NO.: 39

b6

COMMENTS: AIRCRAFT PROBABLY DOWN AT SEA.

HOLLAND, DONNIE R.

SSAN: [REDACTED]
RANK: MAJ
SERVICE: AF
UNIT: 335 FFS (DEPNOTED //4TH TFW)
DTG LOST: 172012Z JAN 91
COORD: 3038N 04740E
STATUS: PMIA
VEHICLE: F-15E
CALLSIGN: T-BIRD 56
RECORD NO.: 4
COMMENTS: CREWMEMBER WAS MAJ KORITZ. SAR SUSPENDED.

b6

KANUHA, DAMON V.

SSAN: [REDACTED]
RANK: SGT
SERVICE: AF
UNIT: 16 SOS (AFSOC)
DTG LOST: 310326Z JAN 91
COORD: 2844N 04816E
STATUS: PKIA
VEHICLE: AC-130H
RECORD NO.: 42
COMMENTS: AIRCRAFT PROBABLY DOWN AT SEA.

b6

KORITZ, THOMAS E.

SSAN: [REDACTED]

b6

(b)(6)

RANK: MAJ
SERVICE: AF
UNIT: 335 TFS (DEPLOYED)//4TH TFW
DTG LOST: 172012Z JAN 91
COORD: 3038N 04740E
STATUS: PMIA
VEHICLE: F-15E
CALLSIGN: T-BIRD 56
RECORD NO.: 5
COMMENTS: CREWMEMBER WAS MAJ HOLLAND. SAR SUSPENDED.

(b)(6)

MAY, JAMES B.
SSAN: [REDACTED]
RANK: MSG
SERVICE: AF
UNIT: 16 SOS (AFSOC)
DTG LOST: 310326Z JAN 91
COORD: 2844N 4816E
STATUS: PKIA
VEHICLE: AC-130H
RECORD NO.: 38
COMMENTS: AIRCRAFT PROBABLY DOWN AT SEA.

(b)(6)

OELSCHLAGE, JOHN L.
SSAN: [REDACTED]
RANK: SSG
SERVICE: AS
UNIT: 16 SOS (AFSOC)
DTG LOST: 310326Z JAN 91
COORD: 2844N 04816E
STATUS: PKIA
VEHICLE: AC-130H
RECORD NO.: 41
COMMENTS: AIRCRAFT PROBABLY DOWN AT SEA.

(c)(f)

PHILLIS, STEPHEN R.
SSAN: [REDACTED]
RANK: CAPT
SERVICE: AF
UNIT: 353 TFS, 354 TFW
DTG LOST: 151327Z FEB 91
COORD: 2957N 04708E (J1/JRCC) OR 03002N 04715E (REPORTED BY UK NCO)
STATUS: PMIA
VEHICLE: A-10
CALLSIGN: ENFIEL 37
RECORD NO.: 62
COMMENTS: DOWNED SAME TIME AS LT SWEET. ACCORDING TO TAPE OF COMMS, SWEET WENT DOWN WITHIN 5-10 KM OF 3002N 04715E. PHILLIS FLOW CAP FOR APPROX 10 MIN. BEFORE BEING SHOT DOWN.

SCHMAUSS, MARK J.

~~NSA~~
RELEA.
DFOI

2

~~SECRET~~

(b)(6)

SSAN: [REDACTED]
RANK: SSG
SERVICE: AF
UNIT: 16 SOS (AFSOC)
DTG LOST: 310326Z JAN 91
COORD: 2844N 04816E
STATUS: PKIA
VEHICLE: AC-130H
RECORD NO.: 40
COMMENTS: AIRCRAFT PROBABLY DOWN AT SEA.

SPEICHER, MICHAEL S. *cott*

SSAN: [REDACTED]
RANK: LCDR
SERVICE: NY
UNIT: VFA-81(S)
DTG LOST: 170200Z JAN 91
COORD: 3245N 04445E
STATUS: PMIA
VEHICLE: FA-18
RECORD NO.: 1
COMMENTS: DOWNED OVER BAGHDAD AND PROBABLY DECEASED HOWEVER, NO EVIDENCE OF DEATH.

(b)(6)

SPELLACY, DAVID M.

SSAN: [REDACTED]
RANK: CAPT
SERVICE: MC
UNIT: VMO-1, MAG 13 (FWD), 3D MAW
DTG LOST: 250954Z FEB 91
COORD: 2901N 04806E (J1) 2849N 04803E (JRCC)
STATUS: PMIA
VEHICLE: OV-10
CALLSIGN: PEPPER 77
RECORD NO.: NONE AT PRESENT
COMMENTS: SAR SUSPENDED. CREWMEMBER WITH MAJ SMALL WHO HAS BEEN RELEASED. INITIAL DEBRIEF OF SMALL INDICATES THAT HE (SMALL) THE BACK-SEATER, EJECTED BOTH HIMSELF AND SPELLACY BUT SPELLACY'S CHUTE DID NOT FULLY DEPLOY. NO MOVEMENT WAS NOTED ON SPELLACY'S PART DURING DESCENT. DURING INTERROGATION BY THE IRAQI'S, SMALL WAS TOLD THAT "HIS PARTNER" WAS DEAD AND THAT THEY HAD BURIED HIM.

REF
DFDI

(b)(6)

TURNER, CHARLES J.

SSAN: [REDACTED]
RANK: LT (O-3)
DOB: 08/03/61
SERVICE: NY (RES)
UNIT: VA-155, USS RANGER
DTG LOST: 181540Z JAN 91
COORD: 3000N 04800E
STATUS: PMIA

SECRET LIMDIS

REPORT OF CASUALTY

1 REPORT NUMBER AND TYPE Sup Rpt 91 Feb 7

2 DATE PREPARED

117020-A-1-a Corrected

1991 Jan 28

3 SERVICE IDENTIFICATION (Name, Social Security Number, Grade or Rate, Component, Branch and Organization), (MOS/NJC) 1st Appt: ENS (USNR) 1980 Oct 31

SPEICHER, Michael Scott [REDACTED] LCDR 004 USN O 1310

4 CASUALTY STATUS a. BATTLE NON-BATTLE b. COMMENCED TOUR DATE INDIAN: 502

c. STATUS DEATH KIA MISSING MISSING IN ACTION CAPTURED OTHER (Specify)

d. DATE 1991 Jan 17 e. PLACE IRAQ

f. CAUSE & CIRCUMSTANCES Failed to return from a combat aircraft strike mission over Iraq.

5 a. DATE AND PLACE OF BIRTH b. RACE c. SEX d. RELIGIOUS PREFERENCE

1957 Jul 12 Kansas City MO Caucasian Male Methodist

6 DATE AND PLACE OF LAST ENTRY ON ACTIVE DUTY IN CURRENT STATUS AND HOME OF RECORD AT TIME

1980 Oct 31 Pensacola FL Jacksonville FL

7 a. PAY GRADE b. BASIC PAY c. INCENTIVE/ADDITIONAL PAY d. CHECK IF APPLICABLE

004 \$3029.10 Over 10 yrs YES NO CREW PASSENGER

8 DUTY STATUS

ACTIVE

DUSTA: COMCARAIRWING SEVENTEEN

9 INTERESTED PERSONS (Name, Address, Relationship) - DATE OF RECORD OF EMERGENCY DATA FORM

[REDACTED] 1,2,3 [REDACTED] [REDACTED] DOB [REDACTED] Same [REDACTED] Same

10 REPORT FOR VA TO FOLLOW YES NO 11 REPORTING COMMAND AGENCY AND DATE REPORT RECEIVED IN DEPARTMENT

COMCARAIRWING SEVENTEEN 1991 Jan 17

12 PRIOR SERVICE DATA YES NO ENL USNR 1980 Jun 17 - 1980 Oct 31

13 REMARKS

[REDACTED] [REDACTED] [REDACTED] Same

FOOTNOTES

- 1. Adult next of kin.
2. Beneficiary for gratuity pay in event there is no surviving wife or child as designated on record of emergency data.
3. Beneficiary for unpaid pay and allowances as designated on record of emergency data.

14 DISTRIBUTION

H- COMNAVBASE CHARLESTON SC

15 SIGNATURE ELEMENT

Certified to be a true Certification of Casualty.

[Signature] Head, Casualty Assistance Branch

By direction of the Commander, Naval Military Personnel Command

(b)(6) (b)(7)

daf

REPORT OF CASUALTY

1. REPORT NUMBER AND TYPE

117020-A-1

2. DATE PREPARED

1991 Jan 28

3. SERVICE IDENTIFICATION (Name, Social Security Number, Grade or Rate, Component, Branch and Organization), (MOS/NJC)

1st Appt: ENS (USNR) 1980 Oct 31

SPEICHER, Michael Scott [REDACTED] LCDR 004 USN O 1310

4. CASUALTY STATUS

a. BATTLE

NON-BATTLE

b. COMMENCED TOUR DATE

INDIAN: 502

c. STATUS

DEATH

KIA

MISSING

MISSING IN ACTION

CAPTURED

OTHER

(Specify)

d. DATE 1991 Jan 17

e. PLACE IRAQ

f. CAUSE & CIRCUMSTANCES Failed to return from a combat aircraft strike mission over Iraq.

5 a. DATE AND PLACE OF BIRTH

1957 Jul 12 Kansas City MO

b. RACE

Caucasian

c. SEX

Male

d. RELIGIOUS PREFERENCE

Methodist

6. DATE AND PLACE OF LAST ENTRY ON ACTIVE DUTY IN CURRENT STATUS AND HOME OF RECORD AT TIME

1980 Oct 31

Pensacola FL

Jacksonville FL

7 a. PAY GRADE

004

b. BASIC PAY

\$3029.10 Over 10 yrs

c. INCENTIVE/ADDITIONAL PAY

YES

NO

d. CHECK IF APPLICABLE

CREW

PASSENGER

8. DUTY STATUS

ACTIVE

DUSTA: COMCARAIRWING SEVENTEEN

9. INTERESTED PERSONS (Name, Address, Relationship)

DATE OF RECORD OF EMERGENCY DATA FORM

1991 Jan 05

1,2,3

DOB

10. REPORT FOR VA TO FOLLOW

YES NO

11. REPORTING COMMAND AGENCY AND DATE REPORT RECEIVED IN DEPARTMENT

COMCARAIRWING SEVENTEEN

1991 Jan 17

12. PRIOR SERVICE DATA

YES NO

ENL USNR 1980 Jun 17 - 1980 Oct 31

13. REMARKS

FOOTNOTES

1. Adult next of kin.
2. Beneficiary for gratuity pay in event there is no surviving wife or child as designated on record of emergency data.
3. Beneficiary for unpaid pay and allowances as designated on record of emergency data.

14. DISTRIBUTION

H- COMNAVBASE
CHARLESTON SC

15. SIGNATURE ELEMENT

Certified to be a true Certification of Casualty.

[Signature]
Head, Casualty Assistance Branch

By direction of the Commander, Naval Military Personnel Command

(b)(6)

~~SECRET~~

ARLINGTON ANNEX
MESSAGE CENTER

ZYUW RUFRRGG9690 0252021

IMMEDIATE/PRIORITY

~~NO P-252021Z JAN 91~~

FM STRKFITRON EIGHT ONE

TO COMNAVMIIPERSCOM WASHINGTON DC//64/66//

INFO ZEN/COMCRUDESGRU EIGHT

ZEN/USS SARATOGA

ZEN/COMCARAIRWING SEVENTEEN

~~SECRET~~ //NO1770//

SUBJ: CO INVESTIGATION REPORT ON MIA PERSONNEL, NMPC-64/66 (U)

MSGID/GENADMIN/VFA-81//

REF/A/DOC/MILPERSMAN 4210100.8//

REF/B/RMG/COMCARAIRWING SEVENTEEN/172038ZJAN91//

NARR/REF A IS PERS CASUALTY REPORTS POLICY FOR FOLLOW-ON RPT BY CO.

REF B IS INITIAL PERS CASUALTY (MIA) REPORT ICD LCDR MICHAEL S.

SPEICHER, USN, 491-52-9897/1310//

RMKS/1. (U) FOL RPT SUBMITTED IAW REF A, AND AS AMPLIFYING INFO TO

REF B.

2. ~~(S)~~ ON 17 JAN 91, VFA-81 FA-18 ACFT SIDE NUMBER AA-403 (BUND 163484), PILOTED BY LCDR SPEICHER, PARTICIPATED IN THE FIRST NIGHT STRIKE MISSION TO SUPPRESS ENEMY AIR DEFENSES IN VCTY OF BAGHDAD, IRAQ. AA-403 FAILED TO CHECK IN UPON COMPLETION OF STRIKE. STRIKE LEADER REPORTED LAST CONFIRMED SIGHTING OF AA-403 WAS AT COMPLETION OF AIRBORNE REFUELING PRIOR TO ENTERING HOSTILE TERRITORY. INTENSE SURFACE-TO-AIR MISSILE, ENEMY FIGHTER ACTIVITY AND ANTI-AIRCRAFT ARTILLERY FIRE WAS ENCOUNTERED BY ALL ACFT IN VCTY OF TARGET.

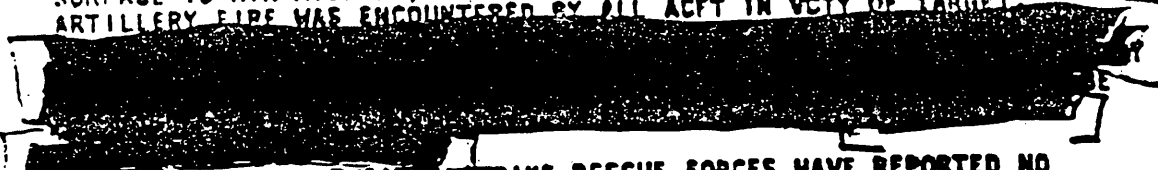

(b)(1)

3. ~~(S)~~ TO DATE, THEATER STRIKE RESCUE FORCES HAVE REPORTED NO VISUAL SIGNALS OR RADIO COMMS FROM LCDR SPEICHER. STRIKE RESCUE EFFORTS WILL CONTINUE UFN. NO FURTHER INFO AVAIL.

4. (C) IVO ABOVE INFO, RECOMMEND LCDR SPEICHER'S STATUS REMAIN AS MIA.

5. (U) RELEASED BY M.T. ANDERSON, USN, CO VFA-81.//
DECL/OADR// BT

CNMPC WASH DC

ACTION NMPC66 (4)

INFO ICC (1) NMPCERC (1) NMPCOO (1) NMPCOIE (1) NMPCO5 (1)
NMPC4 (2) DUTY OFFICER (1) CNP (1) TFK CK-USN (1)

(R.M)

ADV

14

MCN-91026/09567

TDR-91026/0814Z

TAD-91026/0817Z

CDSN-MAC242

PAGE 1 OF 1
252021Z JAN 91

~~CONFIDENTIAL~~

~~FILE COPY~~

MVZCZCCWC007

PTTCZYUW RUFRAF0199 2171210-C-CC-RER-110

ZNY CCCCC

P 171210Z JAN 91 ZYB

FM CTG ONE FIVE FIVE

TO CTF ONE FIVE FIVE

BT

RETURN TO FLAG COMM

CONFIDENTIAL PERSONAL FOR RADM. MIXON FROM GEE//N00000//

SUBJ: MISSING ACFT (U)

MSGID/GENADMIN/CTG 155.2/199/JAN//

RMKS/1. (C) RILEY, THE LOSS OF AA-403 DURING OUR INITIAL BAGHDAD STRIKE IS MOST UNFORTUNATE. AT THIS JUNCTURE, I AM NOT CERTAIN WHAT OCCURRED BUT HAVE COMPILED THE FOLLOWING FACTS FROM AIRCREW DEBRIEFS AND OBSERVATION BY CDR MIKE (SPOCK) ANDERSON;

THE STRIKE LEADER, ALL TIMES LOCAL:

- A. 403 LAST SIGHTED AT TIME 0320, POSITION 29-15NE7/041-00E5 (EAR POINT OF RAISIN TANKER TRACK) HEADING 015 DEGREES TRUE.
- B. ASSIGNED SEAD LAUNCH POINT WAS 015 DEGREES, 268 NM FROM EAR POINT.
- C. 403 DID NOT REPORT TO POST-STRIKE TANKING POSITION AT BRIEFED TIME.
- D.

(6)(1)

~~CONFIDENTIAL~~

CASE - FLAG & DIST _____ COPIES (8)

RETR 35 RUNOFF _____ DIST _____ SUPVR 770 TIC _____

~~CONFIDENTIAL~~

(b)(1)

- 3. (S)
- 4. (S)
- 5. (S)

6. (U) RELEASED BY RADM. G. N. GEE.//
 DECL/OADR//
 ET
 #01 9

~~A~~
 RELE
 DFOI
 With
 Exe.

~~CONFIDENTIAL~~

CASE _____ S. DIST _____ COPIES _____
 HQRTR _____ RUNOFF _____ DIST _____ SUPVR _____ T/C _____

.....
SECRET/SPECAT
.....

Copy
Chrono
Speicher
Turner
Costen
Gooke
Conner
Underwood

NAVAL MESSAGE
DEPT OF NAVY
>>> SPECIAL HANDLING REQUIRED <<<

IMMEDIATE
O 102216Z FEB 91
FM COMUSNAVCENT
TO CNO WASHINGTON DC//OP-01B//

ZYUW RUHGS6G9938 0692215

SECRET SPECAT PERSONAL FOR RADH GALLO FROM SMITH //N00000//
SUBJ: MIA INFORMATION (U)

MSGID/GENADMIN/COMUSNAVCENT//
RMKS/1. (S) ADMIRAL, FOLLOWING INFORMATION IS SUBMITTED IN
RESPONSE TO 9 MARCH TELCON BETWEEN CAPT STEVE LOEFFLER AND MY N3.
THE INFORMATION IS THE BEST WE CAN OBTAIN FROM AIRCREW DEBRIEFS
AND RADIO COMMUNICATIONS RELAYED UP THE CHAIN. WE HAVE
INTENTIONALLY MADE THIS A CLASSIFIED MESSAGE IOT GIVE YOU AS MUCH
DETAIL AS POSSIBLE.

2. (S) THE FOLLOWING NAVCENT PERSONNEL ARE LISTED AS MIA DUE TO
HOSTILE ACTION DURING OPERATION DESERT STORM:

- LCDR MICHAEL S. SPEICHER, USN, [REDACTED] 1310
- LT CHARLES J. TURNER, USNR, [REDACTED] 1325
- LT WILLIAM T. COSTEN, USN, [REDACTED] 1310
- LT PATRICK K. CONNER, USN, [REDACTED] 1310
- CAPT REGINALD C. UNDERWOOD, USMC, [REDACTED] 1320

3. (S) THE LOSSES LISTED PARA 2 OCCURRED IN FOUR SEPARATE EVENTS.
A. (S) Lcdr SPEICHER, VFA-81 (F/A-18), EMBARKED IN USS SARATOGA
WAS CONDUCTING A NIGHT STRIKE MISSION IN THE VICINITY OF WEST
BAGHDAD ON 17JAN91.

[REDACTED]
IT WAS NOT POSSIBLE TO DETERMINE IF THE
AIRCRAFT WAS SPEICHER'S BUT NO OTHER AIRCRAFT WERE LOST. THERE
WERE NO COMMUNICATIONS OR BEACONS REPORTED.

B. [REDACTED]

.....
>> ~~SECRET~~ <<<
.....
>> PERSONAL FOR <<<
.....

CNO WASH DC
ACTION RADH GALLO(1)
INFO OO(1) O9(1) SC(1)

(M)

TOTAL COPIES REQUIRED

MCN=91069/10923 TOR=91069/2314Z TAD=91070/0802Z CDSN=CNT368
..... PAGE 01/03
SECRET/SPECAT
..... 102216Z FEB 91

.....
• ~~SECRET/SPECAT~~ •
.....

NAVAL MESSAGE
DEPT OF NAVY
>>> ~~SPECIAL HANDLING REQUIRED~~ <<<

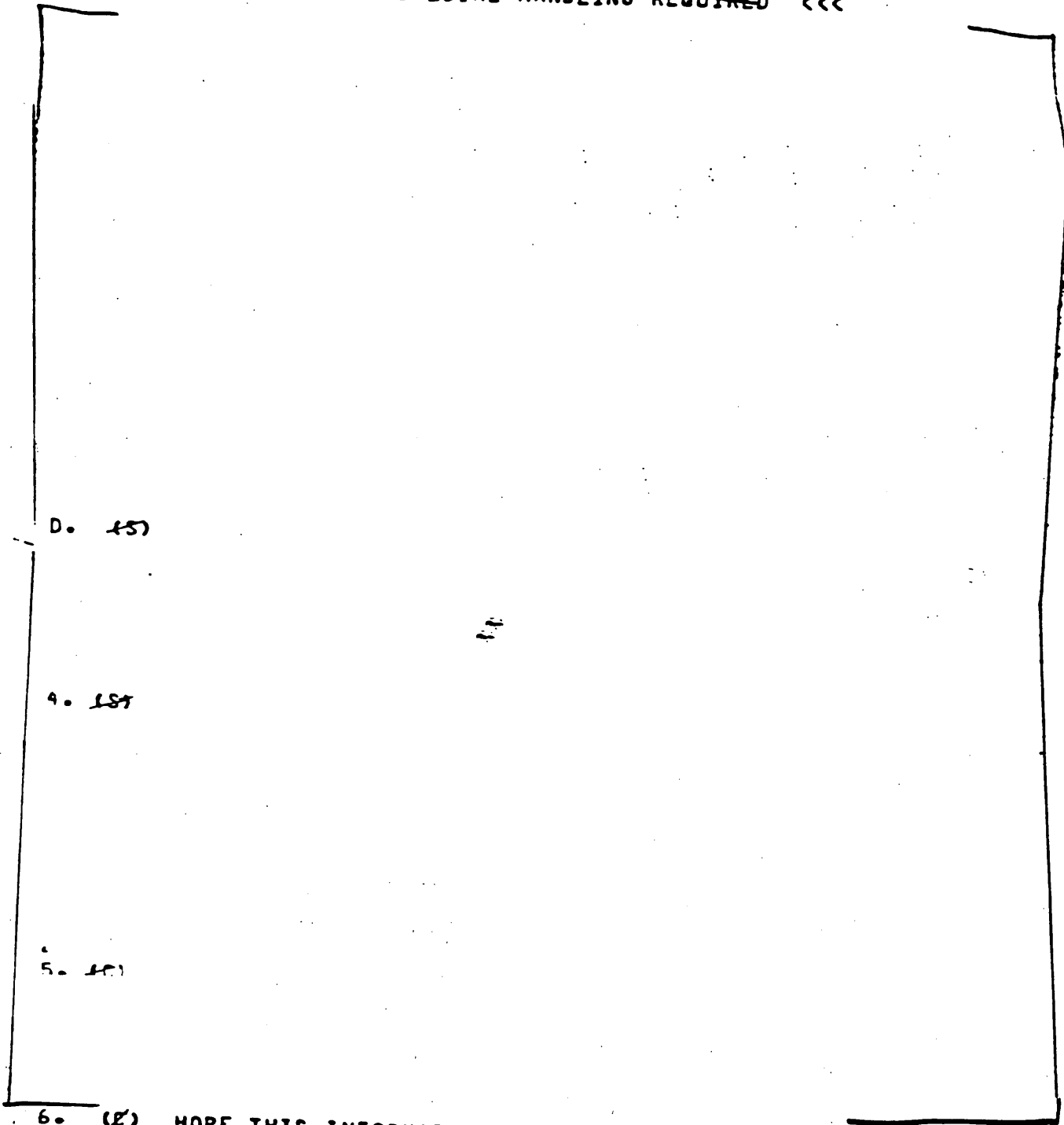

b1

D. 157

4. 157

5. 157

6. (Z) HOPE THIS INFORMATION WILL ASSIST IN DEALING WITH THE
FAMILIES. A CONCERN IS THAT WE RAISE NO FALSE HOPES. USCINCENT
IS COORDINATING WITH COMPONENT COMMANDS AND THE ICRC TO LOCATE

MCN=91069/10923 TOR=91069/2314Z TAD=91070/0802Z CDSN=CN368

.....
• ~~SECRET/SPECAT~~ •
.....

PAGE 02/03
102216Z FEB 91

SECRET/SPECAT

NAVAL MESSAGE
DEPT OF NAVY
>>> SPECIAL HANDLING REQUIRED <<<

AND INVESTIGATE ALL CRASH SITES. WE HAVE DIRECTED COMIDEASTFOR
TO CONDUCT SEARCH OPERATIONS FOR THOSE SITES BELIEVED TO BE IN
THE ARABIAN GULF. WE WILL KEEP YOU INFORMED AS SITUATION
WARRANTS. WARM REGARDS AND VERY RESPECTFULLY. BERNIE.//
DECL/DADR// BT

MCN=91069/10923

TOR=91069/23142 TAD=91070/08022 CDSN=CNT368

..... PAGE 03 OF 03

SECRET/SPECAT

..... 102216Z FEB 91

DTG
FROM
CONTROLS

290202Z JAN 91
FM SSO DIA //IRAQ REGIONAL ITF//

SECRET NOFORN REL UK

QQQQ
SECTION 01 OF 02

/***** THIS IS A COMBINED MESSAGE *****/

BODY

PASS: SSO FORSCOM PASS COPY TO DIA REP. SSO USTRANS PASS COPY TO DIA REP. SSO SAC PASS COPY TO DIA REP. SY SEC SHAPE PASS TO MR. PULSINELLI, DIA REP TO SHAPE. DIRNSA PASS TO G-6/G-64/W-4/W-15/DAZ. SSO DA PASS TO DCS-OPS & PLANS AND DAMI-FIC. SSO USEUCOM PASS TO ECJ2, JIC, AND SOCEUR. SSO SAM PASS TO G2 FIFTH US ARMY.

SUBJ: MILITARY SITUATION SUMMARY (DOD-JIC) SUPPLEMENT AS OF 271900Z JAN 91 (C)

(U) AIR DEFENSE:

(1). (S/NF/RELUK)

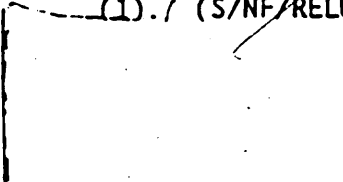

bi

~~NA~~ RELEASE
DFOISR

(2). (S/NF/RELUK) A NAVY F-14 OVER H-2 AIRFIELD AND A NAVY F/A-18 NEAR BAGHDAD WERE REPORTEDLY SHOT DOWN BY SA-2 MISSILES WITHOUT ANY PRIOR WARNING ON THE RWR. THERE IS NO EVIDENCE OF AN SA-2 SITE IN THE H-2 AREA, INDICATING THAT THE F-14 MAY IN FACT HAVE BEEN SHOT DOWN BY AN SA-6 UNIT IN THE AREA. CLOUD COVER REDUCED THE VISUAL WARNING TIME FOR THE F-14 PILOT.

Speicher
Jones
Slade

(3). (S/NF/RFIHK)

(4). (S/NF/RELUK)

(5). (S/NF/RELUK)

(A). (S/NF/WN)

bi

~~NA~~

RELEASE
DFOISR

(B). (S/NF/RELUK)

NOFORN REL UK

***** BEGINNING OF SECTION 002 *****/

(C). (S/NF/RELUK)

(D). (S/NF/RELUK)

(6). (S/NF/RELUK)

01

A.H.
RELEASE of Exempt
DFDISR
1